

Child safety barriers

Study commissioned by:
ANEC (European Association for Consumer
Representation in Standardisation)

Study supervision:
Helena Menezes, project adviser for ANEC

Abstract

In a modern society children are exposed to many different hazards. Different types of safety barriers are often used to protect children from life-endangering accidents such as falling from great heights or falling into swimming pools. Children have a natural curiosity and climbing is a natural behaviour for them. They can and will climb objects in their environment and as they grow older their climbing ability improves.

This study focuses on children's ability to climb barriers and the barrier's effectiveness for children of ages 4 to 6 years. The aim of the study is to obtain complementary knowledge as input to revised standards and recommendations in Europe in order to improve child safety in the built environment.

An experimental study of child safety barriers has been carried out with 157 participating children in the ages 4-6 years. The relatively large sample size is necessary because there is a considerable variation in both mental and physical abilities in the age groups considered.

The designs of the barriers used in the study have been chosen based on a literature survey. In this limited study it has been considered necessary to focus on a few archetype barriers, which are considered most effective, and to vary properties of these within the limits which can be accepted from economic and aesthetic points of view.

Since the most able children in the age groups studied can climb such barriers, barriers must be seen as a method of increasing the time for children to enter a dangerous area rather than as providing complete safety. Hence, the time it takes for a successful climb is a relevant parameter to study.

The results show that simple barriers with vertical bars or solid panels and heights 1.1 m – 1.2 m can be climbed by around half the children within 30 seconds also in the lower age groups, and that the difference in height is not very significant.

The most effective barrier in this study is the one which is inclined towards the climber.

Key words:

Child safety, climbing, barriers, stairs, balconies, pools, building codes, fences, drowning prevention, fall prevention

SP Sveriges Tekniska Forskningsinstitut
SP Technical Research Institute of Sweden

SP Report 2009:32
ISBN 978-91-86319-20-5
ISSN 0284-5172
Borås 2009

Contents

Abstract	2
Contents	3
Summary	4
1 Literature survey	7
1.1 Physical and psychological aspects of climbing capacity	7
1.2 Barriers and children's climbing capacity	8
1.3 Testing with children	9
1.3.1 Special considerations	9
1.3.2 Friction	9
1.3.3 Statistical considerations	10
1.3.4 Sequential sampling	10
1.4 Rules, regulations and standards	12
2 Designs and features of test barriers	15
2.1 Test barrier A: Vertical bars, height 1.1 m	18
2.2 Test barrier B: Vertical bars, height 1.2 m	18
2.3 Test barrier C: Vertical bars, height 1.2 m, 100 mm top profile	19
2.4 Test barrier D: Vertical panel, height 1.2 m	19
2.5 Test barrier E: Vertical bars, height 1.2 m, inclined 15° towards the climber	20
3 Experimental study	21
3.1 Composition of test group and test plan	21
3.2 Testing	23
3.2.1 Preparations	23
3.2.2 Test performance	23
3.3 Documentation	24
4 Results and discussion of results	25
4.1 Climbing technique	25
4.2 Number of children passing the barrier	27
4.3 Time delay	28
4.4 Results distributed by age, height and gender	29
5 Conclusion and future work	31
References	33
Appendix A Pre-study	35
Appendix B Letter to parents	38
Appendix C Diagrams of the result	39
Appendix D Photos from practical test	45
Appendix E Percentile estimation	50

Summary

Children are a vulnerable group in society. They have a natural curiosity and climbing is a natural behaviour for them. They can and will climb objects in their environment and as they grow older their climbing ability improves.

Child safety barriers are intended to protect children from hazards and accidents such as falling into swimming pools and falling from balconies. Drowning is, in some parts of the world, the leading cause of accidental death in and around the home for children. Falls are another major cause of serious injury or death of children.

This study focuses on the effectiveness of different designs of child safety barriers with regard to safety of children in ages 4 to 6 years. The aim of the study is to obtain complementary knowledge as input to revised standards and recommendations in Europe in order to improve the design of barriers in the built environment, thereby improving the safety of children.

A literature survey is performed as a background for an experimental study. It is found that in a limited study as the intended one it is necessary to focus on a few types of archetype barriers which are considered to be the most effective ones, and to vary properties of these within the limits which can be accepted from economic and aesthetic points of view.

Several papers on the climbing capacity of children focus on the importance of anthropometric measures and the considerable dispersion in those for various ages. It has also been reported that children experience significant development of both psychological and physical abilities in the ages between 4 and 6, causing this age group to be of highest interest to investigate.

A survey of rules and standards reveals considerable differences in specifications and details although the variation in some of the vital measures, such as the overall height, spacing of vertical bars etc., is rather small. The child maximum age limit presumed to be protected by the standards is typically set at 5 or 6 years for barrier heights of 1.1-1.2 m.

An experimental study of child safety barriers has been undertaken. The experimental study extends the knowledge about children's capacity to climb typical barriers, and can be used as a basis for suggesting improvements to standards and rules, to prevent young children from having accidents around balconies, stairs, pools etc.

The design of the test barriers has been chosen based on materials and designs used in barriers available in the building sector. Parameters such as height, top profile and inclination were chosen to be variables in the testing based on findings of the literature survey and based on designs of commercially available safety barriers.

A test rig making it possible to set up different barrier configurations has been constructed and used for climbing experiments in nursery schools. The experiments have been performed so that they conform as much as possible to the daily activities of the children.

The testing group was comprised of 157 children ages 48 to 70 months (inclusive). Five different barriers were tested and each child climbed two test barriers.

The results show that simple barriers with vertical bars or solid panels and heights 1.1 – 1.2 m can be climbed by around half the children and that 30 – 40 % of the children climbed these barriers within 30 seconds. These barriers were successfully climbed also by the youngest children in this study (4 year olds) and the 10 cm difference in height did not have a significant effect.

The barrier with a wider top (designed to be hard to grip) was more effective. This barrier stopped 80 % of the children. However the children that were able to climb this barrier climbed quickly, more than 10% succeeded within 10 seconds. The children that manage to climb the barrier varied in age and height.

The most effective barrier in this study is the one which is inclined at an angle towards the climber. This barrier stopped almost 90% of the children and no child was able to pass the barrier within 10 seconds. This barrier was also the most effective at delaying the children for at least 30 seconds, 7 % of the children succeeded within that time.

It is nearly impossible to design barriers that will protect all 4-6 year old children. This study has shown that commonly used 1.1-1.2 m high simple barriers are not effective enough. It has also been shown that it is possible, by rather simple means, to improve the safety function to a more acceptable level.

Introduction

Children have a natural curiosity and often do not yet know how to avoid hazards. As children are growing up, they explore their environment and develop their skills. Climbing is a natural behaviour for children and as they grow older they will climb more and more challenging objects in their environment and their climbing ability will improve.

Safety barriers can be used to prevent or delay children's access to swimming pools or other hazards. The motivation is, of course, that accidents are not infrequent. Pool accidents with children, for example, are among the most frequent causes of death of young children in some parts of the world [1]. Fall accidents are also a frequent cause of death and serious injuries among children. Like all safety products, a child safety barrier has to be a compromise as there must be a balance between the demand of safety and the demands of function and aesthetics.

The purpose of this project is to identify design features that contribute to the effectiveness of the barrier in making it more difficult to climb or increasing the time for a child to come in contact with a hazard. It is also important to investigate for which ages and anthropometric data of children typical barriers are effective. The additional knowledge achieved is then intended to be used as input for revision and harmonisation of national and EU rules and standards in this area.

This project focuses on rigid barriers for buildings and swimming pools using designs and materials currently available in the building sector in Europe. The age group of children in focus is 48 to 70 months.

The project consists of a literature survey and an experimental study. The literature study focuses on existing definitions, rules and regulations world-wide, test methods as well as on children's ability to climb. In the experimental study, practical tests of different barrier designs are carried out with children in nursery schools.

1 Literature survey

This literature survey serves as a background for an experimental study of barriers intended to prevent 4-6 year old children from being killed or injured due to falls around balconies, stairs and swimming pools. Swimming pool accidents with children are among the most frequent causes of death of young children according to WHO [1] and most drowning accidents involve children under 5 years of age.

For this study it is vital to get an overview of the existing knowledge about the general capacity of children to climb at different ages, and which features of barriers make it easier or more difficult for children between the ages of 4-6 years to climb.

Likewise, a sample of previous studies, which may have been used as background for existing standards and rules, is useful as reference and for comparison of results. Such studies differ considerably in aim, scope and methodology, and they typically are performed on a wide range of barriers.

Finally, an indispensable piece of knowledge is about present rules and recommendations in different countries. Rules in different countries have been established in different ways and with different background, e.g. regarding building traditions and local performance of building materials such as wood, steel, concrete, glass etc. Also, the experience and views of consumer and building authorities should be taken into account. These rules and standards have to be analysed in order to make acceptable suggestions for a harmonised approach.

1.1 Physical and psychological aspects of climbing capacity

The general climbing capacity has been studied by van Herrewegen et al. [3] and Neto et al. [2]. In [2], a thorough overview is made on the development of mental and physical skills of children and of their anthropometric measures. They also investigated climbing techniques developed and used by more and less agile children. The success of climbing different barriers is correlated not only to age, height and weight in the study but also to a number of anthropological measures such as length of arms and legs, width of chest and head and hand strength. Not surprisingly there is a considerable dispersion in properties among the children, and the correlations between climbing capacity and the more obscure measures such as chest breadth are rather weak. However the study showed that the tall children were more likely to succeed in climbing the barriers [2]. For practical purposes these complicated interactions point to the necessity of having large enough samples of children.

In van Herrewegen et al. [3], as well as in [2], the psychological aspects are considered. For different children the physical properties are blended with psychological ones. It appears that both an inherent talent and agility, and living conditions such as the presence of brothers and sisters etc. play important roles for the total capacity of being a good climber. Characteristics of good and bad climbers are listed and compared in [3], in which it is also demonstrated that many rather young children can climb high fences, in some cases as high as 140 cm.

In [2] it is concluded that a significant development of motor ability occurs in the ages 4-6 years. In [3] it is stated that until the age of 4 the difference in physical aspects as

strength between boys and girls is not significant, but after that the boys develop more strength but not necessarily better climbing skills. A quality that seems to be significant is height [2]. In [3] it is pointed out that a 4 year old child can be taller than a 6 year old child. Therefore height might be a more important parameter than gender.

In the present study, testing is performed in Sweden. Therefore, the height of Swedish children is an important parameter. The Swedish growth charts according to Albertsson-Wikland et al. [20] differ by approximately plus 3% from the CDC [19] growth charts. Consequently Swedish children are slightly taller than the average of European children.

1.2 Barriers and children's climbing capacity

A very relevant paper focusing on children's ability to climb barriers was written by Nixon, Pearn and Petrie [4]. The aim of the study was to define minimal requirements for barriers which are effective and can find community acceptance, the authors being worried that the present standard might be too lax or not compulsory. They conducted tests with 515 children of whom 122 were girls, in the ages between 2 and 8 years. The tests were performed in nursery schools and elementary schools. Seven different barriers were used made of commercially available components and with heights of 60, 90, 120 and 140 cm. Unfortunately no design details were revealed. It was found necessary to randomize the order of attempts to eliminate fatigue effects. For the four heights, cumulative frequency curves of success as a function of age are presented. Also, the results are presented in a table where results for genders are given separately. The difference between genders was not significant, although it is known that difference in strength occurs from 5 years. A very interesting result is that the majority of children from 4 years and older can climb even the 120 and 140 cm barriers. In [4] it is concluded that the time to succeed for a child to climb these barriers is short, as low as 5-20 seconds.

In the study by van Herrewegen et al. [3], results for a variety of barriers of heights 122, 137 and 152 cm showed that many rather young children could climb high chain link fences, proving that this is not an effective barrier design. The study also showed that some of the children between 3 ½ and 4 years can climb picket and stockade barriers up to 137 cm, which is probably higher than can be accepted in a standard regulation for practical, aesthetic and economic reasons.

In the study of Neto et al. [2], the barriers were vertical plates of varying height complemented with horizontal bars. In this study, it was again concluded that many of the children were successful, and that the time to climb was short, normally less than 30 seconds. The study also showed that having the handhold placed higher makes it more difficult for children to climb. The additional horizontal bars helped the children to successfully climb the barrier. The children were allowed to use a box as a foothold while making their attempt to climb. It was stated that, if no foothold was used while climbing a 1.1 m high barrier, the number of children that pass the barrier will be reduced by nearly half (83.7% to 43.2%). Because the practical test in our study will be barriers in this height range, it was decided that it was not necessary to test barriers with footholds. Another important observation in [2] is that a spacing of 11 cm is large enough to allow the body of a small child to pass through, but not the head. A spacing of this dimension could therefore lead to a possible life-endangering hazard of entrapment. Neto et al. [2] also concludes that there are no absolutely safe barriers of a reasonable design, and that it is not possible to foresee which child can and can not climb a certain barrier.

Another interesting investigation was performed by Rabinovich et al. [5] which specifically addresses barriers for residential pools. It is focused on 4 ft (122 cm) barriers recommended as a minimum by the US Consumer Product Safety Commission [6], but

they also used 4 ½ ft (137 cm) and 5 ft (152 cm) barriers. Children between the ages of 2 -4 ½ years old who were thought to be particularly good climbers were chosen. Chain link, ornamental iron, stockade and picket barriers were used, and an interesting detail is that additions as rollers or protruding plates were added on top in order to make the climbing more difficult. Significant differences are registered between the types of barriers. The higher iron stockade and picket barriers, both of which have vertical bars and no footholds, are more or less completely effective up to 4 years. For the 4 ft (122 cm) barriers an angled and over-shooting plate at the top is a more effective obstacle than the roller. No statistically significant gender difference was found.

The time of delay is an important property of a safe barrier as it gives the caregiver time to react. In Nixon et al. [4] as well as in [2] and [3] it is registered that the time for children to successful climb a barrier is often less than 30 seconds. In [2] the time 30 seconds is compared to the time it takes to fill a 1 ½ liters bottle with water. This indicates that children climb barriers very quickly and the time for a caregiver to react is short.

For an investigation of the basic properties of effective barriers, it is essential to eliminate various types of hand- and footholds to avoid biased results that are not comparable to other studies.

1.3 Testing with children

1.3.1 Special considerations

In the test situation it is important that the children feel comfortable and safe. Hence it is important to conduct the test in an environment they know and that the atmosphere is relaxed. Both in van Herrewegen et al. [11] and in [4] the tests were conducted at a nursery school. There should be adults around the test object to catch the children if they fall, and the area around the test object should be prepared with cushioning material.

Motivation is also an important factor for the outcome of these types of tests. To get the children interested in climbing the barrier they should be in a good mood, rested and not hungry. Some studies [2] and [5] have had attractive toys or some kind of encouragements in the top of the barrier. It could also encourage the participants to climb when they are looking at other children [2] and [5]. For the ages of interest here, 4-6 years, a more mature approach can probably be used by giving the participants a small gift as a token of appreciation for their help.

When testing with children it is important that children are not stimulated later to climb on real barriers. Therefore it might be a good idea to give the test object a different design than regular barriers. In Rabinovich et al. [5] the barriers looked like a play platform or a toy. The barrier can also be colourful to strengthen the impression of a toy. Still, the properties of standard building market products should be retained.

1.3.2 Friction

One important parameter for the climbing capacity is the friction between the feet and the material in the barrier. Any kind of footwear would strongly influence this parameter, a child wearing shoes with rubber soles would be more likely to be able to climb a barrier than a child with footwear of lower friction. However, one important application for barriers in this project is domestic pools, and for this application bare feet climbing is highly relevant. The friction between human skin and a material in a barrier is a result of many parameters such as roughness/smoothness of the barrier material and of the

condition and humidity of the skin. For skin and glass a study performed by Derier et al [23] concludes that the “friction” is a result of adhesion and viscoelastic deformation of the skin. That study showed that for smooth glass adhesion is the determining factor and for rougher glass surfaces the deformation of the skin was the most important factor.

It could be assumed that footwear and clothing influence the ability to climb. However in the test reported in [3] children’s clothing does not significantly influence the climbing. This statement however was based on tests [11] that were conducted outdoors where the children were either barefoot or wearing shoes. However it can be assumed that the friction and climbing ability would be different if the children only wear socks. In and around swimming pools it seems common that children would be barefoot. It also gives equal test conditions for all children if the tests are conducted barefoot.

1.3.3 Statistical considerations

When performing tests with a sample of children, some statistical considerations have to be made with regards to representativeness. Ideally, a large sample from the whole population of children studied (European, Nordic etc.) should be used, since there are so many influencing factors and such large variations among children. This cannot be fully accomplished for practical reasons, and it is necessary to make some statistical considerations when deciding the sample size and test procedure of the test. A useful statistical tool for considerations about samples is the statistical binomial distribution, which is described in the textbook Montgomery et al. [13].

If the test situation may be considered as a number of independent trials with the outcome success or failure they can be considered Bernoulli trials which are able to be analyzed using the binomial distribution. Among other things, the standard deviation of the percentage of success may be estimated.

Also a confidence limit for the shortest time for successful climbing for a certain percentage of the whole population of children may be estimated.

1.3.4 Sequential sampling

In standards for acceptance tests, sequential sampling plans are defined to give satisfactory OC (Operating Characteristics). Such sampling plans are also built on the binomial distribution.

Consider the following example. A barrier is accepted if none of thirty children succeed in a test. If ten or more of the children succeed, the barrier is rejected. However, if 1-9 children succeed, the sequential test plan allows additional tests to be used in order to reach a decision. If e.g. one child succeeds in the first test, it is required that none of five additional children succeed in a second series of tests.

Such a testing procedure is constructed from the Operating Characteristics of the sampling plan, defined by its

1. Acceptance Quality Limit (AQL) that represents the poorest level of quality that a consumer would consider to be acceptable as an average.
2. Limiting Quality (LQ, LTPD, RQL or LQL) that represents the poorest level of quality that the consumer is willing to accept for an individual item.
3. The probability α that is the probability of rejection of an acceptable product.
4. The probability β that is the probability of acceptance of a non-acceptable product.

A detailed description of acceptance sampling for attributes can be found in Montgomery [12]. Examples of test methods for child protective functions that use sequential samplings plans are Nordtest method NT CONST [21] and SS-EN ISO 8317:2004 [22]. The sequential chart of the later standard is shown in Figure 1.1.

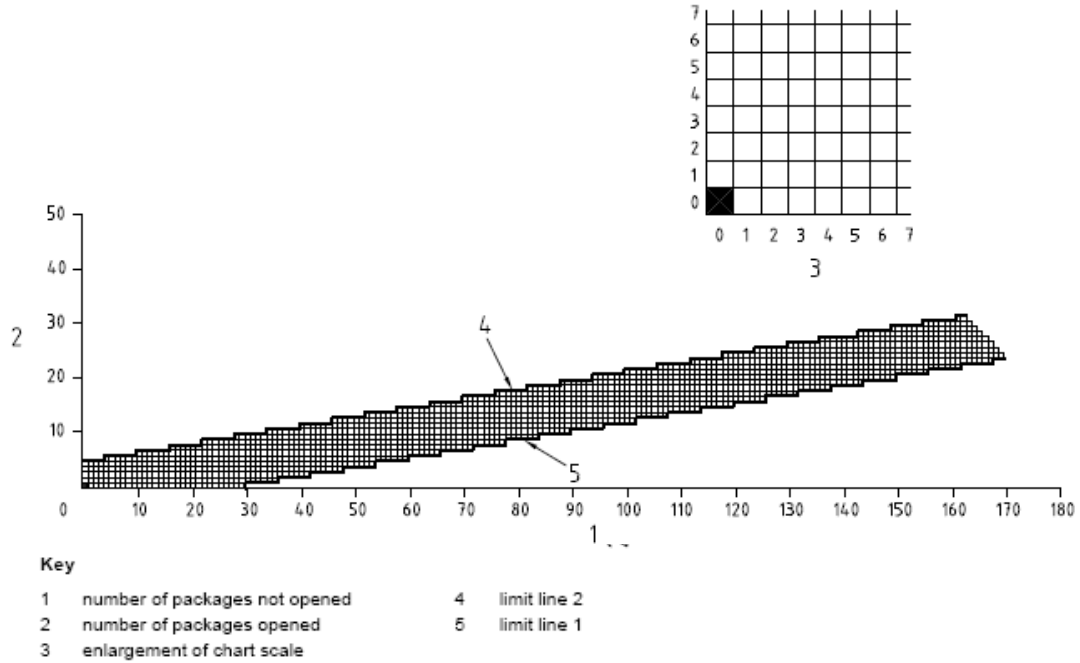

Acceptable quality limit (AQL) = 5 %; limiting quality (LQ): 20 %; $\alpha = \beta = 5$ %, where α is the producer's risk; β is the consumer's risk.

Figure 1.1. Chart of a sequential child test procedure from SS-EN ISO 8317:2004 [22].

1.4 Rules, regulations and standards

Present rules and standards are varying, see Table 1.1, both for pool fences and for barriers in general. The first five of the standards in Table 1.1 address barriers for swimming pools and the others address general barriers. The specifications are also normally general and allow for variations that may unintentionally facilitate climbing. This should be kept in mind when analysing and proposing different solutions aimed at uniformity and at a better and more transparent correlation between the design of a barrier and its ability to prevent climbing. It is worth noting that pool accidents are most common for smaller children up to 3 years, while children of all ages are subjected to fall accidents.

Table 1.1 Regulations and standards.

Standard/ Regulation	Country/ Region	Height [m]	Gaps [mm]	Mesh [mm]	NCZ* [m]	Age*** [year]
WHO	World	1.2	100	-		
CPSC	US	1.2	100	45.5		
AS 1926.1-2007	Australian	1.2	100	13-100**	0.9	5
NZS 8500:2006	New Zealand	1.2	100	10-53**	0.9	6
NF P 90-306	France	1.1	102		1.1	5
BS 6180:1999	UK	1.1	100			5
EN 1176-1:2008	Europe		89			
BFS 2008:6 BBR 15	Sweden	1.1	100			

* NCZ - Non climbable zone

** Depends on height of the barrier

***Upper limit of protected age group

To help preventing drowning of young children in swimming pools, the WHO [1] recommends that barriers should be 1.2 m high and have no hand- or footholds that could enable a young child to climb it. It is also concluded that the safety barrier is not a hazard itself in terms of entrapment if the gaps are smaller than 10 cm. These two measures, height and gap between bars, seem to be the ones that are specified in most standards. There is some variation even in those.

Regarding gaps, it is recommended by the US Consumer Product Safety Commission (CPSC) [6] that they should be less than 4 inches (10.16 cm) to prevent a child from being squeezed. According to the Swedish code BFS 2008:6 BBR 15 [9] horizontal openings above the balcony front should be designed so that children cannot get stuck with the head, and the range of 110-230 mm should be avoided. To prevent small children from getting through with the torso and getting stuck with the neck/head, the gap should be limited to 89 mm [10]. In EN1176-1:2008 the range of 89-230 mm must be avoided for openings (89 x 157 mm being the dimensions for the "torso" probe). [14], [15] and [16] give maximum gaps of 100 mm. To find a reasonable limit, anthropology data of head and body dimensions for small children 6-12 months can be studied. According to BS 7231-1:1990 [8] a 6 month old infant's head has a diameter of 140 mm. Because the head is not round, the test probe for a small head is between 100 and 130 mm in diameter SS-EN 1176-1:2008 [10].

For the other measure, the overall height, there is a slight distinction between pool and other barriers. In several other countries such as the US [6], Australia [15] and New Zealand [14] the height 1.2 m seems to be generally adopted together with other specifications on gaps, footholds etc. The height requirements for general barriers in

buildings in Europe seem to be lower than for pools in the US, Australia and New Zealand. In BS 6180:1999 [16] and several other codes, such as [7], a height of 1.1 m is specified, but lower heights can be found as low as 0.9 m [2]. The variation of barriers in buildings may be the result of compromises. There are practical and aesthetical aspects on high barriers. Views of the public opinion must be balanced and blended with those of authorities and industry in consumer related issues.

In this context, it is of interest to note that requirements for occupational safety of barriers in temporary building constructions are rather modest, as the 1.0 m given in [18]. Of course, the intention of those are not to prevent active efforts to pass the barrier, but the comparison gives interesting food for thought when discussing effective means for protection against falling.

The upper limit of the age groups intended to be protected is of course important information for users, in connection with the construction specifications given. The UK building code [16], the French and Australian standard on swimming pool fences [17], [15] all refer to children up to 5 years, while the New Zealand standard [14] uses an age of 6 years.

Since it has been shown in [2] that not even a 1.5 m high barrier stops a 5-6 year old in some cases and that many 4-5 year old children can climb commercial barriers between 1.2- 1.4 m, it is important to investigate means by which the barrier will be more difficult to climb and increase the time to pass. In [5], one test with a wide plate on top was shown to reduce the success of passing over the barrier. That test was done only with children aged 3-4 years.

It should be noted that the total height is not a sufficient specification of a child safety barrier. Designs that makes it possible to grip with hands or feet will make the climbing easier and make it possible to climb higher heights than what would otherwise be possible. Children need only a small area to use as a foothold. For example, in SS-EN 1930:2000 [7], the test method requires 55 mm² in a 55° slope to be a foothold. The area that is needed for a foothold is dependent on the type of climbing object. In many standards the recommendation is that the barrier should have no hand- or footholds. In [14] and [15] the concept of a non-climbable zone (NCZ) of 900 mm is used. This means that there should not be any hand- or foothold within a height zone of 900 mm of the barrier although the total height is higher. As an example, a horizontal bar at 100 mm above the floor, which is very common, is more or less equivalent to decreasing the total height by that amount.

The geometry of the top of a barrier, and other foot- or handholds, is hence important to define. Sloping, glossy surfaces with large radii are difficult to grip. In the French standard NF P90-306 [17] and [10], a rather detailed description of acceptable handholds is given. In [10] a good grip is defined between 16 mm to 60 mm. Other standards, such as [10] or [18], give measures for openings in panels or sizes of meshes in fences. In [14] and [15], the depth of surface projections and indentations is limited to 10 mm.

There are clear indications that an inclination of the barrier towards the climber makes it more difficult to climb. In [15], it is stated that the barrier can be leaned away from the pool with max 15°.

Finally, there are requirements for meshed fences. These are mostly intended for higher fences, but are also used in pools in some cases. In (CPSC) [6], for fences of chain link type, no part of the diamond-shaped opening should be larger than 1.75 inches (4.45 cm). In [14] and [15], if the maximum mesh aperture is 13 mm, the fence must be at least 1.2 m high. Larger apertures require much higher fences. An example of this is that for an

aperture of 35 mm, the fence must be 1.8 m high. This is due to the fact that this type of fence is very easy to climb.

In summary, existing standards give many useful hints on how barriers should be designed, though requirements in some seem to be insufficient. There is also a considerable need for harmonisation and clearer specifications.

2 Designs and features of test barriers

A test rig was built of steel tubes ($\text{Ø}20 \text{ mm}$) and beams, see photo 2.1. The test rig's barriers were constructed of telescopic bars adjustable in height (1.0 -1.3 m) and also with the possibility to incline (0-15°). Common barrier materials were used so that the barrier closely resembles an actual consumer product. The width of the barrier is 1.75 m, which is large enough to make it stable and to prevent the children from using the end posts of the test rig as an aid when climbing.

The test rig was built of two climbable barriers with a distance between them of 2.2 m. This made the testing efficient because the child could climb the first barrier and then directly attempt to climb the second one.



Photo 2.1. The unpainted test rig with vertical bars.

All tested barriers were painted colourfully to imitate toys or play ground equipment, see photo 2.2. The purpose of this was to avoid encouraging the children to climb safety barriers after participating in the tests.

The parts of the test rig not meant to be climbed were covered with shock absorbing material to avoid injuries if the child should fall or come in contact with the test rig.



Photo 2.2. The test rig was painted and protruding parts were covered with shock absorbing material.

The test rig was tested with respect to efficiency and stability in a pre-study with five children participating. The result of the pre-study is found in appendix A.

The design of the test barriers has been chosen based on materials and designs used in barriers available in the building sector. Parameters such as height, gaps, top and inclination have been chosen based on the findings of the literature survey, results from pre-study and features of commercially available safety barriers. The parameters of the test barriers are presented in Table 2.1. More detailed information and sketches of the barriers are found under chapter 2.1 – 2.5.

Table 2.1 Parameters of test barriers.

Barrier	Height	Construction type	Top profile	Inclination
A	1.1 m	Vertical bars	40 mm	0°
B	1.2 m	Vertical bars	40 mm	0°
C	1.2 m	Vertical bars	100 mm	0°
D	1.2 m	Solid panel	40 mm	0°
E	1.2 m	Vertical bars	40 mm	15°

The height of the barriers in the tests were 1.1 m in test barrier A and 1.2 m in test barriers B-E.

Vertical bars are commonly used in barriers and seen as not easily climbable and were therefore a natural choice for this project. The vertical bars in the test barrier A, B, C, E were painted steel tubes and had a diameter of 20 mm. The barriers with vertical steel bars had a maximum gap width of 89 mm. The maximum width of the gaps was chosen according to the European standard for Playground equipment [10] thus preventing entrapment of small children.

Besides bars, solid panels are also common on the market. The solid panel barriers on the market can be made of different materials such as wood, concrete, fibreboard, glass and polycarbonate. For test barrier D, a solid panel of polycarbonate was chosen as polycarbonate has a smoother surface than concrete and most wood products and is easier and safer to handle than glass. The transparency of the material also makes it possible to supervise the children during testing, which is an advantage for documentation purposes.

Two different top profiles were used (see photo 2.3 and 2.4). The 40 mm wide and rounded top profile of lacquered wood was chosen as it is a common design of barriers in the building sector. According to the European standard for Playground equipment [10], dimensions between 16 and 60 mm are considered to provide a good grip. To be able to evaluate the influence of gripability on the results, a 100 mm wide and rounded top profile of lacquered wood was also chosen. 100 mm is considerably larger than the 60 mm that is the limit for good grip according to [10]. To prevent children from grabbing over and around the top profile, the hard to grip top profile was equipped with 150 mm vertical backing, photo 2.5.

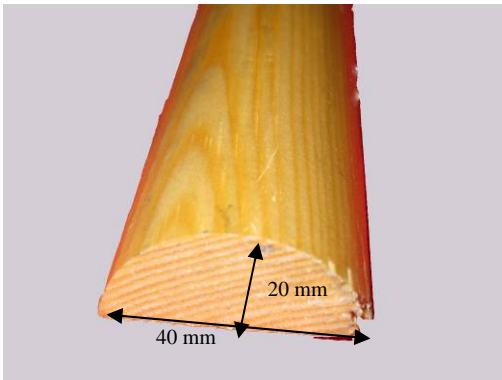

Photo 2.3. 40 mm wide top profile.

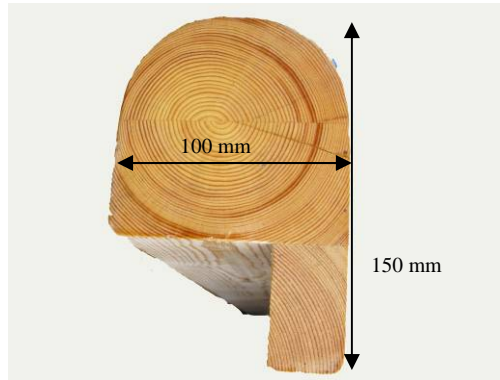

Photo 2.4. 100 mm wide top profile.



Photo 2.5. 100 mm wide top profile mounted on the barrier.

2.1 Test barrier A: Vertical bars, height 1.1 m

The first test barrier was a basic barrier with vertical steel bars. The total height was 1.1 m and the width of the top profile was 40 mm. The height of 1.1 m is recommended as minimum height in a number of countries such as France, UK and Sweden. This barrier was chosen because it is a common type of barrier and commonly accepted as difficult to climb or “safe for children” and we would like to compare it with the other barriers and determine up to which approximate age/height it makes it difficult to climb over the barrier.

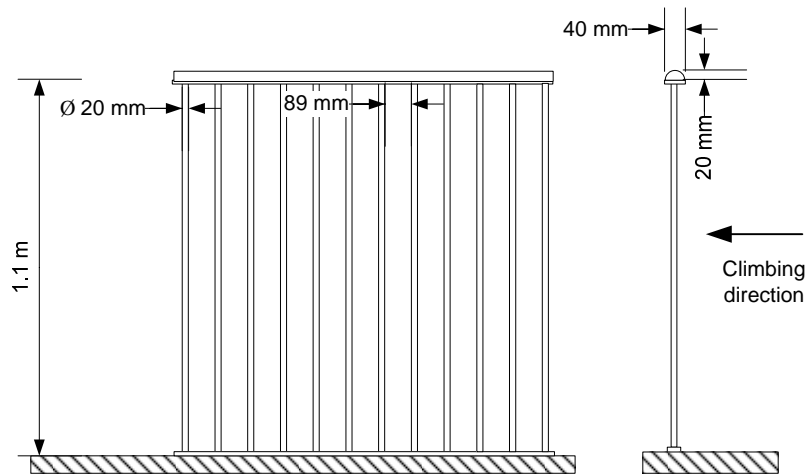

Figure 2.1. Test barrier A: Vertical bars, height 1.1 m.

2.2 Test barrier B: Vertical bars, height 1.2 m

The second test barrier was of the same design as test barrier A but with a total height of 1.2 m. The height of 1.2 m is recommended as minimum height in some countries such as the USA, Australia and New Zealand. This barrier was chosen because it is a common type of barrier and we would like to compare the results with those of the 1.1 m high barrier to determine if the additional 10 cm height makes it more difficult for children to climb over the barrier. Barrier B is also used for comparison to the barriers with wide top profile, panel and inclination.

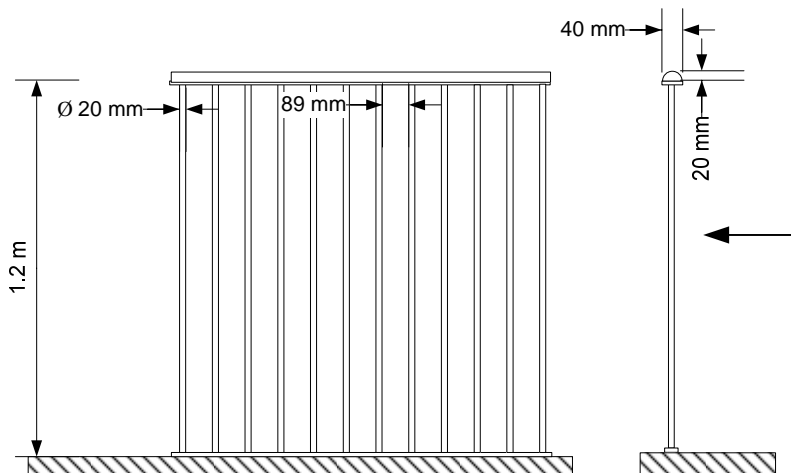

Figure 2.2. Test barrier B: Vertical bars, height of 1.2 m.

2.3 Test barrier C: Vertical bars, height 1.2 m, 100 mm top profile

To evaluate the influence of a “hard to grip” top a 100 mm wide top profile was mounted on a barrier with the same design as test barrier B.

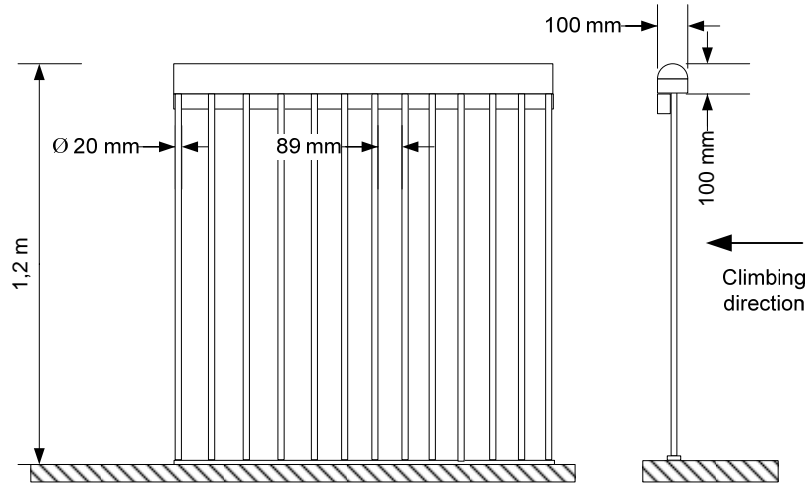

Figure 2.3. Test barrier C: Vertical bars, height of 1.2 m, 100 mm top profile.

2.4 Test barrier D: Vertical panel, height 1.2 m

To evaluate the difference between solid panel and vertical bars a polycarbonate panel was mounted on a 1.2 m high barrier (test barrier B).

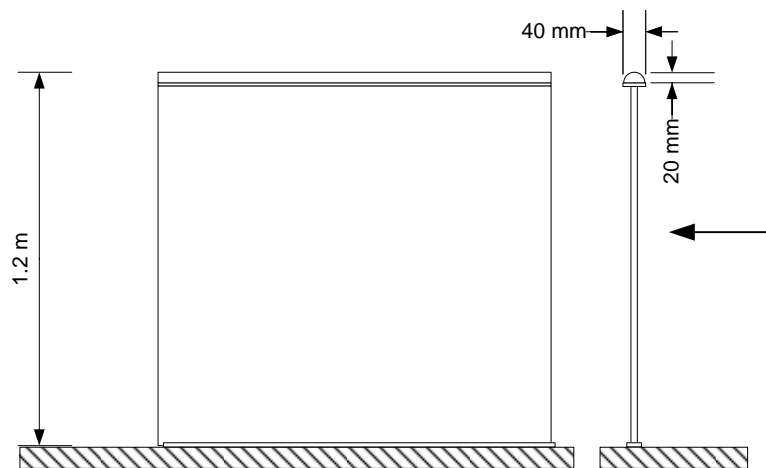

Figure 2.4. Test barrier D: Vertical panels, height of 1.2 m.

2.5 Test barrier E: Vertical bars, height 1.2 m, inclined 15° towards the climber

To evaluate the influence of inclination, a 1.2 m high barrier (same design as test barrier B) with vertical bars was inclined 15° towards the climber.

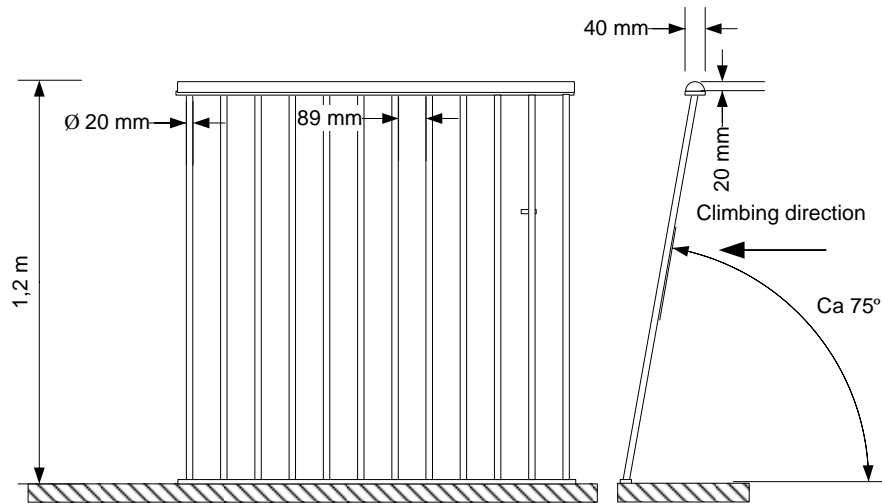

Figure 2.5. Test barrier E: Vertical bars, height of 1.2 m, inclined 15° towards the climber.

3 Experimental study

The purposes of the experimental study are to follow up previous studies by assessing and defining more clearly the important features of barriers, and also to investigate for which ages and anthropometric data of children typical barriers are safe.

The experimental studies were performed with children at nursery schools. With this type of testing, the statistical considerations of sample size and bias sources as discussed in chapter 1.3.

3.1 Composition of test group and test plan

157 children between the ages of 48 and 70 months (inclusive) participated in the practical testing of barriers. The children were healthy, with no evident physical handicap that could affect their climbing ability. It was not possible to have a fully representative distribution of children with respect to age, family conditions, the child's home district and other parameters that might influence the climbing ability.

In Sweden, children start school in August the year they turn six years old. The practical study was conducted in October to November so if the study should include children up to an age of 72 month (6 years) the test also would have to be conducted at elementary schools and not only at nursery schools.

The weight and height of the participating children are plotted in Diagram 3.1. The spread of height and weight is large e.g. there are 4 year old children that are as big as a 5.5 year old child.

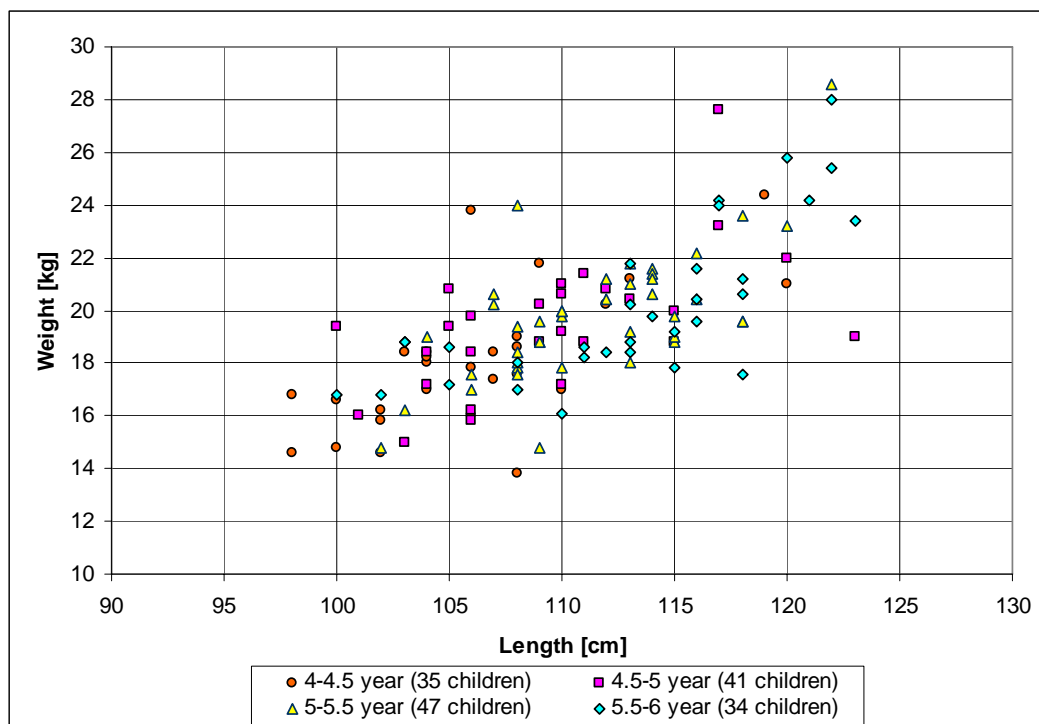

Diagram 3.1. Participating children's height and weight divided in age groups.

The practical test was conducted at nursery schools which were located in Borås city and in the countryside near to Borås. Borås is a smaller town in the south west of Sweden

with around 100 000 inhabitants. In Sweden, children have access to forests, park environments, and to playground equipment with climbing frames in both the city and in the countryside. Therefore, the children's previous climbing experience should not be dependent on what part of the country they live in.

In the tests each child attempted to climb two different barriers. The first attempt was on the barrier that was judged to be the easiest to climb. The test was conducted according to the test matrix in Table 3.1 and the distribution with respect to gender is presented in Diagram 3.2.

Table 3.1 Test matrix.

No. of children	First barrier	Second barrier
34	A	B
35	A	D
47	B	C
41	B	E

As shown in Table 3.1 and in Diagram 3.2 a larger number of children climbed test barriers A and B. This was chosen because these barriers represent a type of barrier that is commonly used and considered to be safe for children up to 5 years old. It is therefore important to try to find out if these barriers are safe and which height could be regarded as safe.

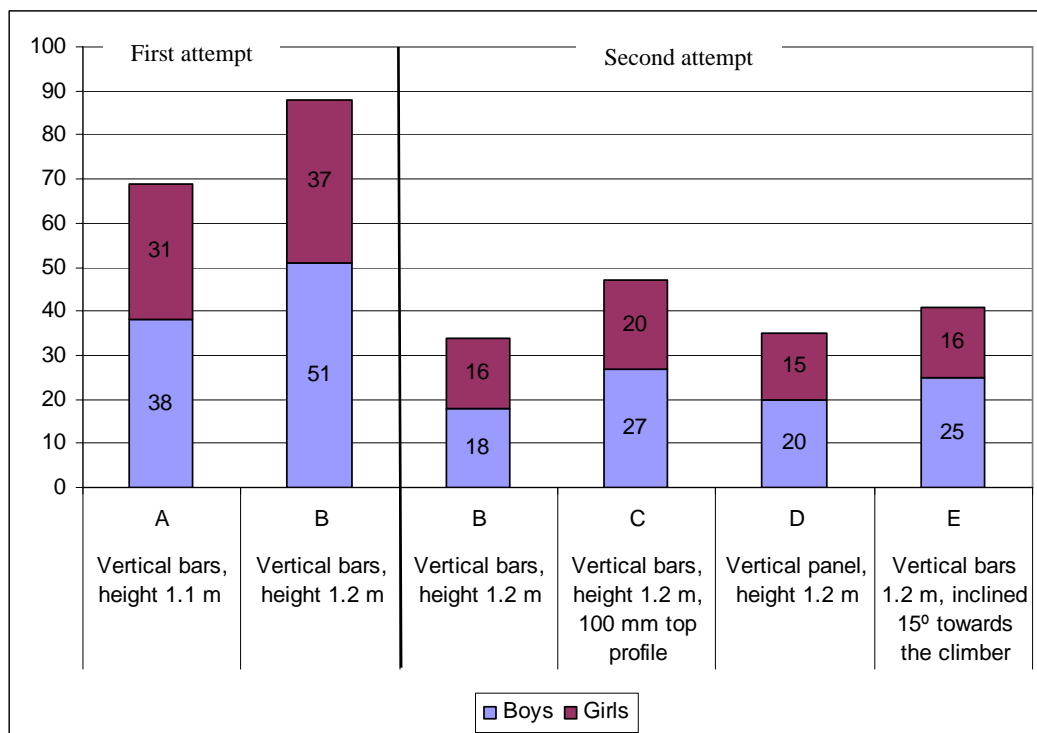

Diagram 3.2 Number of participants distributed by barriers and gender.

Each child's first attempt was only compared to other children's first attempts and the second attempt was compared with other second attempts.

By having the children climb two barriers, fatigue will have some effect on the outcome of their second attempt. It was judged that this effect would be more or less the same for all children and that it should not affect the results of the tests.

3.2 Testing

The practical testing was performed at nursery schools where the children are familiar with their surroundings and relaxed. If the child wish the day care teacher was present during the test. The test was performed before noon while the children were alert.

3.2.1 Preparations

The parents were informed by mail (Appendix B) of the purpose of the study and what their child was going to be asked to do. The parents were also informed that their children's height, weight and gender were going to be recorded and that the tests were going to be filmed and that photographs would be taken. They were also told that no pictures of the children's faces or names will be published. The parents were asked to sign to approve that their children were participating in the study.

The children who were selected to participate in the test were between 48 and 70 months old and they had not been involved in any sort of serious climbing accidents. The children had no physical handicaps or mental barriers that made them unable or scared to climb.

3.2.2 Test performance

The rig with the barrier structures was mounted in an undisturbed room at the nursery school. The children were asked to be barefoot during test in order to ensure that the children's footwear did not influence the outcome of the tests. Each child was encouraged to go in front of the barrier and try to climb over the barrier. The test leader then encouraged the child to get over the barrier, but the test leader did not provide any advice or assistance.

It was important that everything possible was done to prevent the children from getting injured during the test. Testing personnel were present during the test to catch the children if they fell. Observe that two adults were required to be present during the test who were able to catch the children if they fell. One adult was on each side of the barrier, see photo 3.1.



Photo 3.1. Climbing children and test personnel.

The non-climbing children were allowed to be in the test room, but were not allowed to help or affect each other while climbing.

During each test there were two to four children in the test room. This was to make them feel comfortable and safe. The children were allowed to watch each other's attempt to climb. Although this might give them some insight as how to best climb the barrier, the anthropological aspects should stop the ones that are truly incapable of climbing the barrier. In real life children will watch and imitate each other.

3.3 Documentation

The children's age and gender were given by the care giver. The height and weight were measured before the test. The children were asked to stand on a scale and the weight was recorded. When the height of the children was measured, they were asked to place their heels against the wall and look straight forward.

During the test, the child and the barrier were filmed for further analysis of climbing technique and photographs were also taken.

The climbing times were recorded because the time delaying effect of the barrier is an important factor. The time delay gives caretakers more time to react and stop the child from climbing.

After the test, the participating children received a small gift as a token of our appreciation for their help.

4 Results and discussion of results

In this chapter the results and the children's climbing technique from the tests and discussions of these are presented. Diagram 4.1 and Table 4.1 give an overview of the results. Results distributed by age, height and gender of children are presented in Diagram 4.2-4.4. More detailed results are presented in Appendix C.

In the following, barriers A and B (first attempt) will be compared separately since they were tested as first attempts. Barriers C-E will be compared to barrier B (second attempt) since they all were tested as second attempts.

4.1 Climbing technique

The used climbing techniques were quite similar for all children, see photos from the tests in Appendix D. All participating children reached the top of the barrier but not all got a good grip. The tall children used their height and jumped up to the top and swung their legs over the top, see photo 4.1. The shorter or weaker children climbed the bars with help of grabbing around the bars with the toes, see photo 4.2.



Photo 4.1. Children swing up one of the legs to pass the barrier.



Photo 4.2. Child gripping with the toes around the bars.

When climbing the panel barrier the children used the friction between the polycarbonate and the skin, see photo 4.3. The children got a better grip with their feet and some children felt more comfortable climbing the panel than the bars, which could feel uncomfortable between the toes.



Photo 4.3. Child using friction while climbing barrier D (panel).



Photo 4.4. Child grip the hard to grip top profile.

The climbing technique for test barrier C (hard to grip top) are similar to the technique that were used when climbing test barrier B (bars), see photo 4.4.

The barrier E (inclined) were harder to climb since the feet slide on the bars and the body weight made it harder to climb over. This barrier requires tall or strong children, see photo 4.5.



Photo 4.5. Child climbing inclined barrier.

It can be noted that many children were afraid to jump from the barrier while reached the top. The test personnel some times had to lift the children down.

4.2 Number of children passing the barrier

In Diagram 4.1 the percent of children who managed to pass the barrier for each test structure is reported.

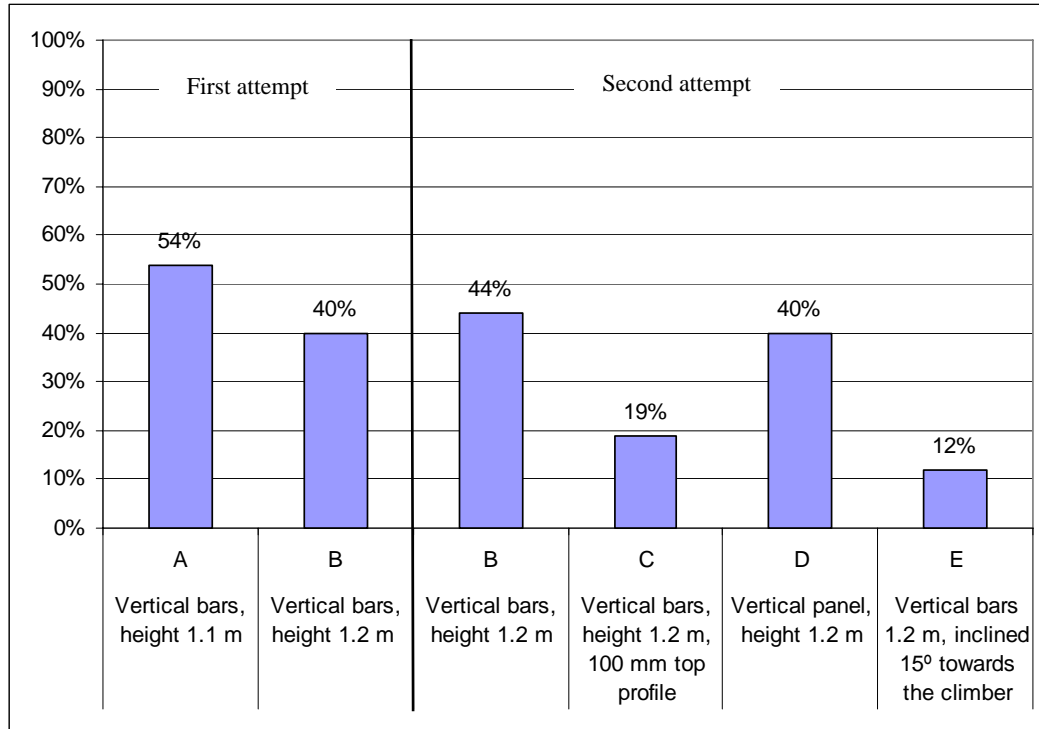

Diagram 4.1 Percents of children passing different types of barriers.

To assess the results statistically, the 95% confidence intervals for success, p , were approximated by, [13],

$$p = f \pm 2 \cdot \sqrt{\frac{f(1-f)}{n}},$$

where f is the observed success rate in n tests. The formula assumes that n is relatively large.

This elementary statistical analysis shows that the confidence intervals for the tests were $54 \pm 12\%$ (barrier A), $40 \pm 10\%$ (barrier B), $44 \pm 17\%$ (barrier B), $19 \pm 11\%$ (barrier C), $40 \pm 16\%$ (barrier D) and $12 \pm 10\%$ (barrier E) success rate respectively.

It is important to note that large confidence intervals are indicated. This shows that there is some significance in the barriers C and E being more difficult to climb, yet larger samples of children are necessary to get more statistically significant results.

However the results still give a number of interesting indications, i.e. that increasing the height with 10 cm from 1.1 m to 1.2 m (barriers A and B) only results in a marginal improvement of safety function.

For the barriers B and D (1.2 m with vertical bars and 1.2 m with panel) the results indicate that the child safety function of the panel barrier (D) is equivalent to the barrier with bars (B). The results also indicate a relatively low safety function for these barriers as 40% of the children were able to pass these barriers.

Another important indication from these results are that barriers C and E (1.2 m with a wider 100 mm “hard-to-grip” top profile and 1.2 m inclined 15° towards the climber) were significantly more effective than B and D. In the test with the barrier C 80 % of the children were unable to pass the barrier and for the inclined barrier E almost 90 % of the children were prevented from passing the barrier.

4.3 Time delay

It is important not only to evaluate the number of children who manage to pass the barrier but to also evaluate the climbing time, as the delay in time will make it more likely for a parent or care taker to be able to intervene and thereby preventing the child from getting in contact with hazard.

To evaluate the time delaying effect of a barrier, the percentages of children who manage to pass the barriers within 10 seconds and within 30 seconds are presented in Table 4.1. The table also includes the estimated lower limit of the 25th percentile. A description of the calculation of the 25th percentile is given in Appendix E. The lower limit of the 25th percentile means that there is a high confidence (98%) that no more than 25% of all children are quicker than the value indicated. In this case it was not possible to use a lower percentile than 25th but it would naturally be desirable to use a lower percentile.

Table 4.1. Study of time delay.

Barrier	Descriptions of barrier	Freq. of children passing within < 10 s	Freq. of children passing within < 30 s	Lower conf. limit of 25th perc.	Freq. of children NOT passing the barrier
A	Vertical bars, height 1.1 m	22%	43%	8 sec	46%
B	Vertical bars, height 1.2 m (first attempt)	7%	28%	17 sec	60%
B	Vertical bars, height 1.2 m (second attempt)	9%	35%	13 sec	56%
C	Vertical bars, height 1.2 m, 100 mm top profile	11%	19%	11 sec	81%
D	Vertical panel, height 1.2 m	9%	34%	11 sec	60%
E	Vertical bars 1.2 m, inclined 15° towards the climber	0%	7%	72 sec	88%

The results presented in Table 4.1 indicate that the increased height of 10 cm (barrier B) had a positive effect on the time delaying. The number of children who were able to pass the barrier quickly were reduced compared to the results for barrier A.

Results for barriers B and D are similar with respect to time delaying effect indicating that barriers with panels are equal in a safety aspect.

The test barrier C with the wider “hard to grip” top profile stopped 80% of the children to pass but the children who manage to pass were able to do this within 20 seconds.

With respect to time delay the results indicate that the inclined barrier (E), is the most effective. No children passed this barrier within 10 seconds and the time corresponding to

the lower confidence limit of 25th percentile is higher than corresponding times for the other barriers.

4.4 Results distributed by age, height and gender

It is often assumed that age, height and gender of a child are correlated to the climbing ability. Naturally there is also a correlation between age and height but this is not as strong as could be expected, see Diagram 3.1. However, age and height are important parameters and therefore the results have been evaluated with respect to these parameters, see Diagram 4.2 and 4.3. Results related to gender are presented in Diagram 4.4.

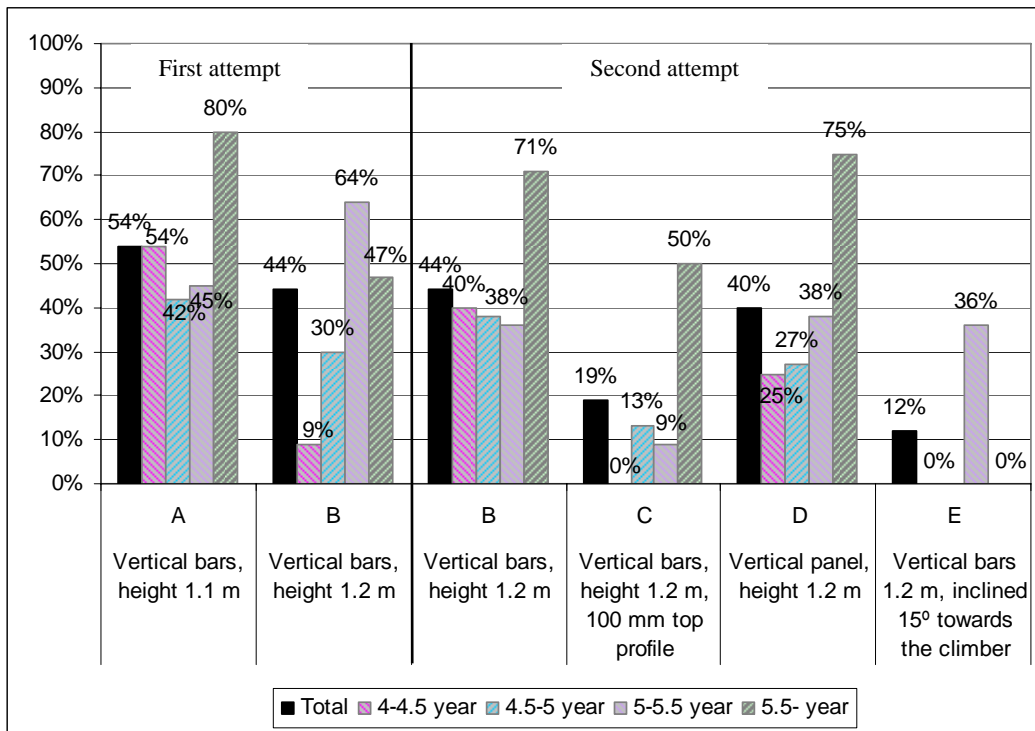

Diagram 4.2 Percents of children passing the barrier distributed by barriers and age.

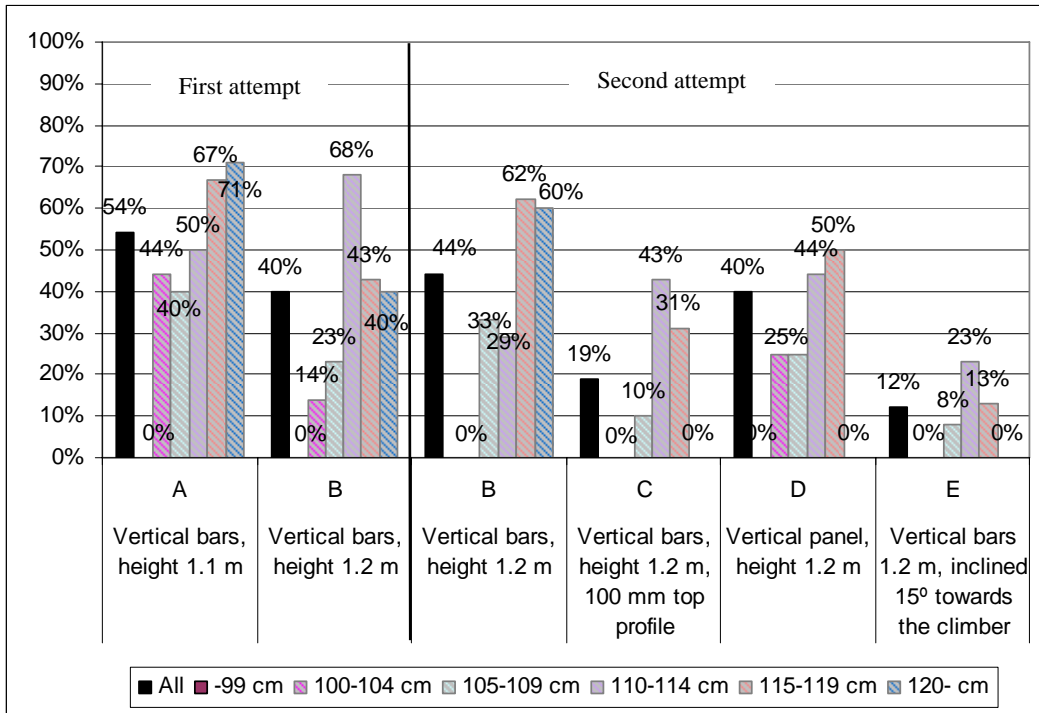

Diagram 4.3 Percents of children passing the barrier distributed by barriers and height of children.

The number of children is not large enough to statistically determine what age or height are protected by each barrier. However there is an indication that it might be possible to protect younger children by using barrier E. In other studies such as Rabinovich et al.[5] it has been stated that stockade and picket barriers are safe for children up to 4 year.

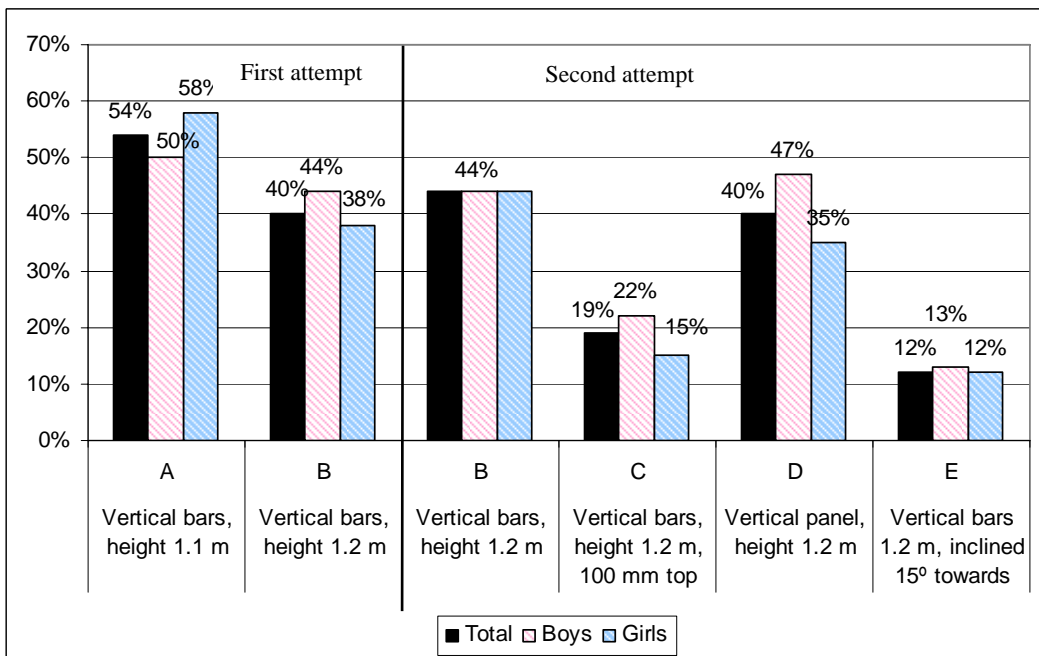

Diagram 4.4 Percents of children passing the barrier distributed by barriers and gender.

The results show no significant difference between gender. Nixon et al. [4] and Rabinovich et al.[5] made the same observation in their studies.

5 Conclusion and future work

Generally it is hard to construct barriers that will protect all children. An important conclusion is that no fool proof rules for safety barriers design can be given, and that safety is achieved when barriers are combined with care and education.

The barrier's height is often assumed to be the most important parameter of a child safety barrier and a barrier height of 1.1 m is often recommended as minimum height and is commonly accepted as difficult to climb and "safe for children" up to 5 years old. In this study this type of barrier stopped less than half of the children and can therefore not be considered to be safe for children in ages up to 5 years. This requires for a design of barriers that differs from the design of the majority of the ones commercially available today.

In the present study, testing was performed in Sweden. Therefore, the height of Swedish children is an important parameter. The Swedish growth charts according to Albertsson-Wikland et al. [20] differ by approximately plus 3% from the CDC [19] growth charts. Consequently Swedish children are slightly taller than the expected average of European children. This is not a big difference but using them for European purposes would possibly be slightly on the conservative side, however products covered by European standards should be safe also for children in the Nordic countries.

In this study, increasing the height of the barrier from 1.1 m to 1.2 m slightly reduced the number of children who were able to pass the barrier. However, still 40 % of the children were able to pass this barrier and this is not an acceptable result for a child safety barrier. To provide good enough safety function by increasing the height, it would be possible to design a very high barrier but barriers much higher than 1.2 m would probably not be acceptable from a practical and aesthetical point of view. Therefore other features need to be added to the design.

The results of this study show no significant difference between the barrier with vertical bars and the one with a smooth surface solid panel. For a panel barrier a very slippery surface would probably reduce the climbability of the barrier but with the commercial building material used today, low friction materials are probably not relevant for use in child safety barriers.

One of the most important functions of a child safety barrier is to increase the time for a child to reach a potential danger. None of the basic barriers (plain bar and panel) in this test gave acceptable delay of time, 30-40 % of the children managed to pass the barrier within 30 seconds and 10-20% managed to pass the barrier within 10 sec.

By studying the number of children who were unable to pass the barriers it could be assumed that barriers with the wider top profile should be an effective barrier, as 80% was unable to pass this barrier, but with respect of time delay this barrier was not much better than the basic barriers. 11 % of the children passed this barrier within 10 seconds.

With respect to time delay, the reasonably effective barrier was the inclined barrier. None of the children were able to pass the barrier within 10 seconds and less than 10% were able to pass within 30 seconds. Inclination of the barrier towards the climber had a positive effect both with regard to the number of children stopped and to time delay. In this study an inclination of 15° degrees was used. A larger inclination is probably even more effective but this might be in conflict with practical and esthetical requirements.

Hand- or footholds on a barrier would help children to climb. Some standards [14], [15] use the concept of Non-Climbable Zone (NCZ). This means that there should not be any hand- or foothold within a specific height zone of the barrier. In our test the height corresponding to NCZ was 1.15 m and even though many children managed to climb the barrier. This gives an indication that the height with no hand- or foothold should not be lower than 1.15 m. This would mean that there should be practically no hand- or footholds on a child safety barrier.

As concluded above the basic property of a child safety barrier is to prevent children from getting in contact with a specific hazard, such as a pool. However, this type of barrier has to be safe also with regard to other child safety parameters as it is placed in the environment of children. When designing a child safety barrier it is therefore important also to consider that there should be no potential source of injury such as protruding parts, dangerous gaps, sharp edges etc.

Both age and height of children are parameters that could be expected to influence the climbing ability of children and therefore would be of importance for the classification of child safety barriers. As stated in chapter 1 there are several physical and psychological aspects that influence the children's ability to climb. Therefore, it is difficult to determine age or height ranges that are protected within a safety margin. However it can be concluded from this study that basic (plain bar and panel) barriers height 1.1-1.2 m do not provide good enough protection for children of age 4-5 year. Thus there is a need for lowering the protected age interval or revising the requirements in some of the current standards as the requirements and age intervals might be misleading. In this study there is an indication that the inclined barrier might be effective for the younger children in this study (4 - 4,5 years), but to be able to determine this with statistical significance a larger sample of 4 year olds would be needed.

Based on the results of this study it would be interesting to see an additional study focused on children 4-4,5 years old and focusing on designs' parameters shown in this study to be effective, i.e. combining overshooting wide ("hard-to-grip") top with inclination. Different designs of a "hard-to-grip" top would also be interesting to study.

References

- [1] “Swimming pools and similar environments”. Guidelines for safe recreational water environment, Volume 2. World Health Organization (WHO), 2006.
- [2] C. Neto, J. Barreiros, F. Vieira, R. Cordovil, P. Aparício and H. Cardoso de Menezes, “Dimension and Design of swimming pool fences and balcony and stairs barriers to protect children from falling and from passing trough, bellow or above”. Commissioned by ANEC, The European Consumer Voice in Standardization, February 2008.
- [3] J. van Herrewegen, J. Molenbroek and H. Goossens, “Children’s climbing skills”. Commissioned by ANEC, The European Consumer Voice in Standardization, November 2004.
- [4] J.W. Nixon, J.H. Pearn, G.M. Petrie, “Childproof safety barriers”. Australian paediatric journal, Vol 15, 260-262, 1979.
- [5] B. A. Rabinovich, N. D. Lerner and R. W. Huey, “Young children’s ability to climb fences”, Human Factors, Vol 36(4), 733-744, 1994.
- [6] “Safety barriers guidelines for home pools”. Publication No. 362. U.S Consumer product safety commission Washington, DC 20207, 2004.
- [7] SS-EN 1930:2000, “Child care articles - Safety barriers - Safety requirements and test methods”, SIS, Sweden, 2000.
- [8] BS 7231-1:1990, “Body measurements of boys and girls from birth up to 16.9 years – Part 1: Information in the form of tables”, ISBN 0 580 19264 4, British Standards Institution, 1991
- [9] BFS 2008:6 BBR 15, “Boverkets författningssamling – Byggregler” The National Board of Housing, Building and Planning, (in Swedish), 1994.
- [10] SS-EN 1176-1:2008, “Playground equipment and surfacing - Part 1: General safety requirements and test methods”, SIS, Sweden, 2009.
- [11] J. van Herrewegen, J. Molenbroek, “Practical test “Children and ladders””, Commissioned by ANEC, The European Consumer Voice in Standardization, November 2005
- [12] D. C. Montgomery, “Introduction to statistical quality control”, John Wiley & Sons. ISBN: 9780471656319, 2005.
- [13] D. C. Montgomery, G. C. Runger, “Applied Statistics and Probability for Engineers”, ISBN10 0471745898, ISBN13 9780471745891, 2006
- [14] NZS 8500:2006 “Safety barriers and fences around swimming pools, spas and hot tubes”, New Zealand Standards, 2006
- [15] AS 1923.1-2007 “Swimming pool safety – Safety barriers for swimming pools”, ISBN 0 7337 8286 8, Australian Standard, 2007
- [16] BS 6180:1999 “Barriers in and about buildings – Code of practice, ISBN 0 580 33051 6, British Standards Institution, 2001

- [17] NF P90-306, Barrières de protection et moyens d'accès au bassin, Norme Française, 2007
- [18] SS-EN-12811-1:2004 Temporary works equipment –Part 1: Scaffolds – Performance requirements and general design, SIS, Sweden, 2004
- [19] “Clinical Growth charts – Children 2 to 20 years -Stature for age and weight for age - boys and girls”, Centers for Disease Control and Prevention (CDC) www.cdc.gov/nach/
- [20] K. Albertsson-Wikland, Z.C. Luo, A. Niklasson, J. Karlberg. “Swedish population-based longitudinal reference values from birth to 18 years of age for height, weight and head circumference”, *Acta Paediatr*, 2002
- [21] Nordtest method NT CONS 018 “Windows and French doors, child-resistant devices: strength and function”, Nordtest, Finland, 1990
- [22] SS-EN ISO 8317:2004 “Child-resistant packaging – Requirements and testing procedures for reclosable packages”, SIS, Sweden, 2004
- [23] “Friction of human skin against smooth and rough glass as a function of the contact pressure” *Tribology International* Volume 42 Issues 11-12, December 2009, Pages 1565-1574

Appendix A Pre-study

The test rig was tested with respect to efficiency and stability and to get an idea of what children ages 4-6 year were capable of climbing. Five children between the ages of 4.5 and 6.5 tested barriers with different configurations. The result of the pre-study is not statistically significant but gives us an indication. The participating children are distributed in age according to Table A1.

The following barriers were tested:

Test object 1 and 4: 1.1 m respective 1.2 m, vertical bars, 89 mm gaps, 40 mm rounded top.

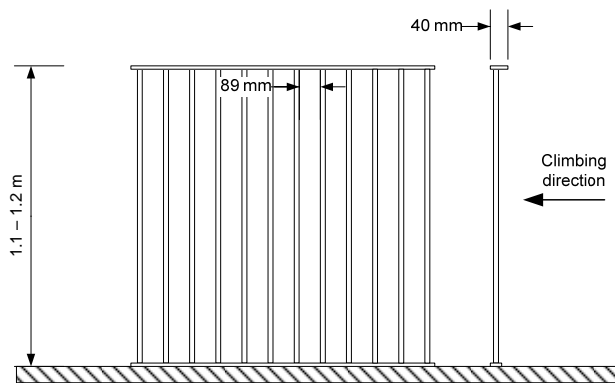

Test object 2 and 3: 1.1 m respective 1.2 m, vertical solid panel, 40 mm rounded top.

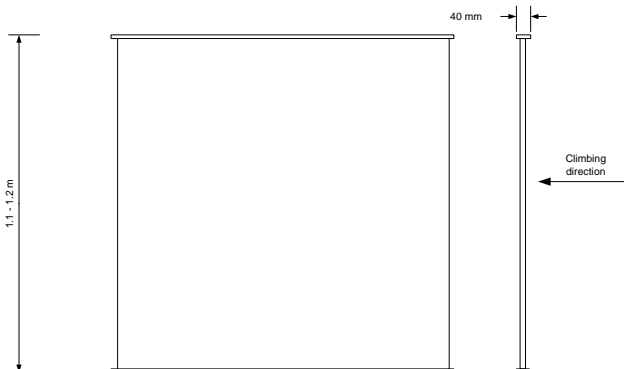

Test object 5: 1.2 m, vertical bars, 89 mm gaps, 40 mm rounded top, inclined 10°.

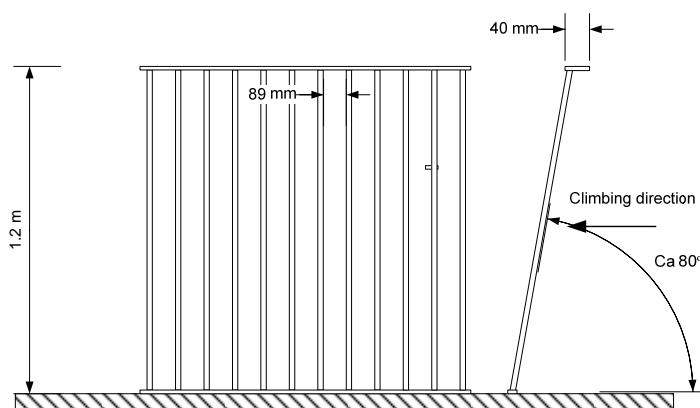

Test object 6: 1.2 m, vertical bars inclined 10° , 89 mm gaps, 145 mm flat top.

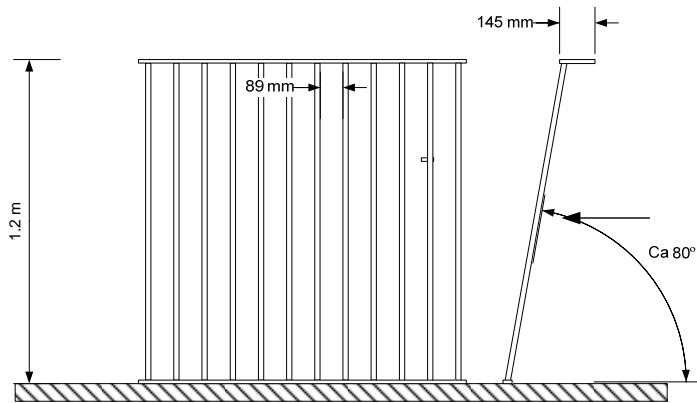

Test object 7 and 8: 1.2 m respective 1.3 m, glass panel inclined 10° , 145 mm flat top.

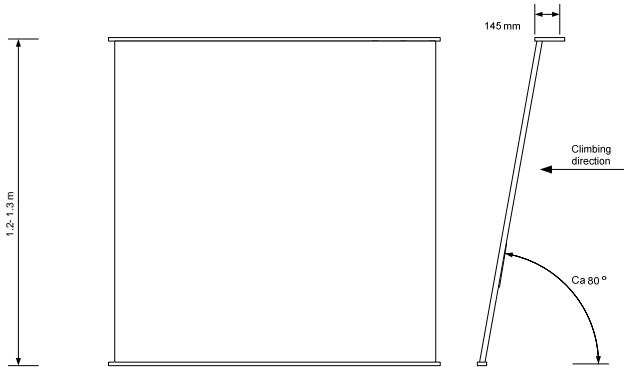

Table A1. Success rate of pre-test.

	6.5 boy	6.5 boy	6.5 girl	5 boy	4.5 girl
Test object 1 1.1 m, vertical bars, 89 mm gaps, 40 mm rounded top.	X	X	X		X
Test object 2: 1.1 m, vertical solid panel, 40 mm rounded top	X	X	X		X
Test object 3: 1.2 m, vertical solid panel, 40 mm rounded top	X	X	X	X	X
Test object 4: 1.2 m, vertical bars, 89 mm gaps, 40 mm rounded top	X	X	X	X	X
Test object 5: 1.2 m, vertical bars, 89 mm gaps, 40 mm rounded top, inclined 10°	X	X	X		
Test object 6: 1.2 m, vertical bars inclined 10°, 89 mm gaps, 145 mm flat top	X	X	X		
Test object 7: 1.2 m, solid panel inclined 10°, 145 mm flat top	X	X	X		
Test object 8: 1.3 m, solid panel inclined 10°, 145 mm flat top	X	X	X		

The 6.5 year old children managed to climb all of the barriers. It is of particular interest to note that the 6.5 year old children all managed to climb a 1.3 m inclined solid panel with a wide top, which could be assumed to be more difficult than most of the barriers used in the main study. The 4.5 year old girl managed to climb 1.1 m and 1.2 m, but not the inclined ones. The 5 year old boy only attempted to climb 1.2 m vertical ribbed and the solid panel with good result.

After climbing some of the barriers, the children learned new techniques which helped them to pass the barriers. This might give some misleading results. If the child had only tested two barriers, they might not have been able to pass the more difficult barriers.

Appendix B Letter to parents



Handläggare, enhet
Patrik Spånglund, Ann-Sofie Engdahl
Bygg och Mekanik
010-516 56 00, Patrik.Spanglund@sp.se
010-516 52 55, Ann-Sofie.Engdahl@sp.se

Datum
2009-11-02

Sida
1 (1)

Till föräldrar vars barn kommer att
deltaga i provning av balkong- och poolräcken

Provning av balkong- och poolräcken

Med detta brev vill vi informera dig om en studie som ska utföras på ert barns förskola. På uppdrag av Europa konsument organisationen ANEC (www.anec.org) genomför SP en studie av barns förmåga att klättra över balkong- och poolräcken. Syftet med studien är att ta fram riktlinjer för hur balkong- och poolräcken ska utformas för att hindra barn att ta sig över eller igenom. Idag finns ingen Europastandard som reglerar hur balkong och poolräcken ska vara utformade.

Vad ska barnen göra?

För att kunna utvärdera vilka faktorer som påverkar möjligheten för barn i åldern 4-5,5 år att klättra över ett räcke behöver vi hjälp av ert barn. Barnen kommer under kontrollerade former och under noga uppsikt försöka klättra över ett räcke. Innan testerna startas kommer vi ha ett informationsmöte med barn och pedagoger på förskolan där vi informerar om provningen.

Vad kommer dokumenteras?

Under studien kommer vi att ta förmånen, mäta längd och vikt. Provnigen kommer att filmas och fotograferas. Varken namn eller bilder med synliga ansikten kommer att publiceras. Bilder och filmer har vi för att analysera hur barnet klättrar.

Föräldrarnas godkännande

För att vi skall kunna låta ert barn vara med i denna provning så måste vi ha ett godkännande från er som förälder. En lista kommer att finnas på ert barns förskola där ni kan skriva på och godkänna provningen.

När?

Studien kommer äga rum torsdagen den 9:e november på ert barns förskola.

Vi vill ha ert godkännande att ert barn deltar i vår provning, var vänlig och signera på den lista som finns uppsatt på ert barns avdelning på förskolan för att ert barn skall kunna deltaga.

Vi hoppas att det ska bli en roande och intressant aktivitet för barnen. Har Ni några frågor eller synpunkter angående studien går det bra att kontakta oss på telefon 010-516 56 00 alt 010-516 52 55.

Med vänlig hälsning

Patrik Spånglund & Ann-Sofie Engdahl

SP Sveriges Tekniska Forskningsinstitut
Bygg och Mekanik – Hållfasthet och konstruktion

SP Sveriges Tekniska Forskningsinstitut

A Member of United Competence

Postadress	Besöksadress	Telefon / Telefax	E-post / Internet	Bankgiro	PlusGiro	Org nummer
SP Box 857 501 15 Borås	Västeråsen Binnellgatan 4 504 62 Borås	010-516 50 00 033-13 55 02	info@sp.se www.sp.se	715-1053	10 55-3	556464-6674

Appendix C Diagrams of the result

Diagrams of the result from the practical test divided by age

Test barrier A: Vertical bars, height 1.1 m (first attempt)

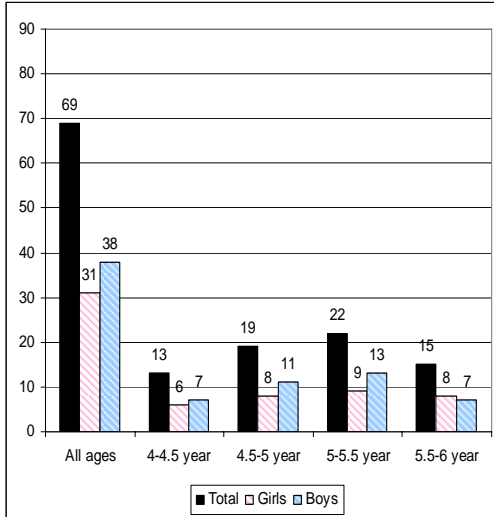

Figure C1. Number of participants.

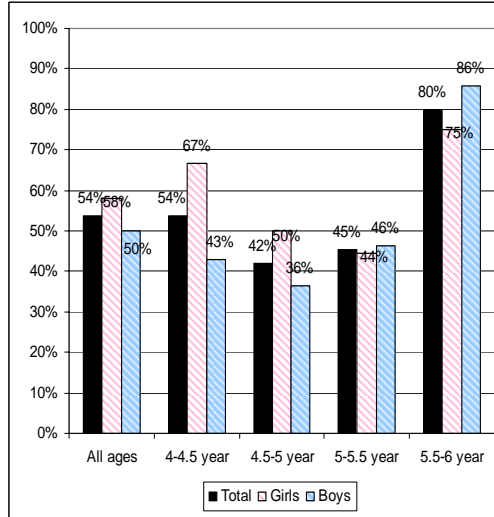

Figure C2. % of success by age.

Test barrier B: Vertical bars, height 1.2 m (first attempt)

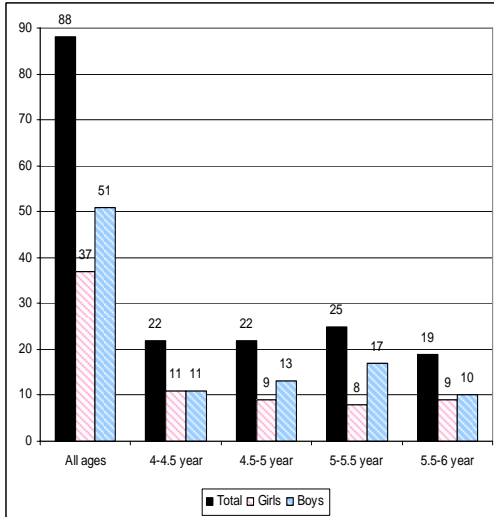

Figure C3. Number of participants.

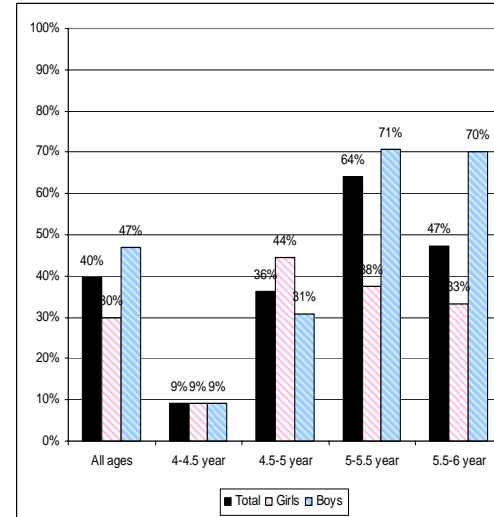

Figure C4. % of success by age.

Test barrier B: Vertical bars, height 1.2 m (second attempt)

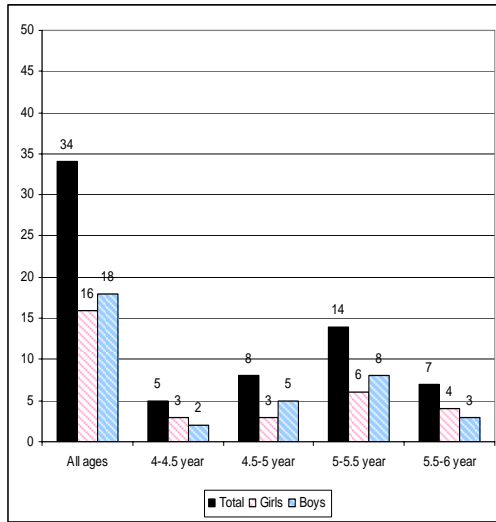

Figure C5. Number of participants.

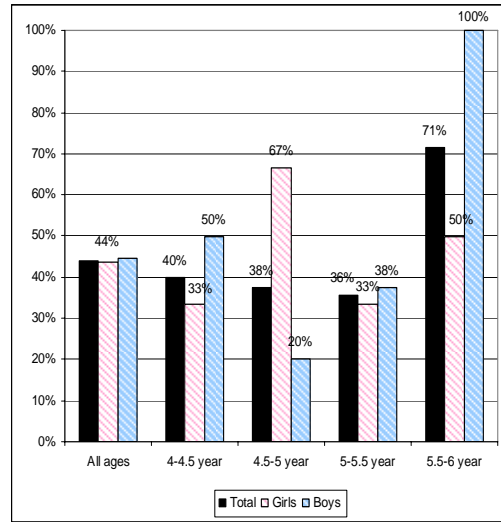

Figure C6. % of success by age.

Test barrier C: Vertical bars, height 1.2 m, 100 mm top profile (second attempt)

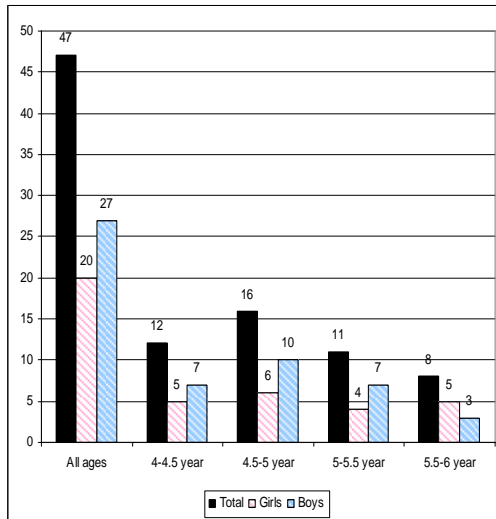

Figure C7. Number of participants.

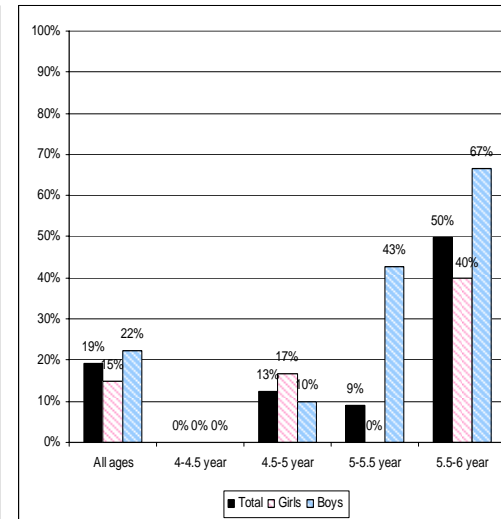

Figure C8. % of success by age.

Test barrier D: Vertical panel, height 1.2 m (second attempt)

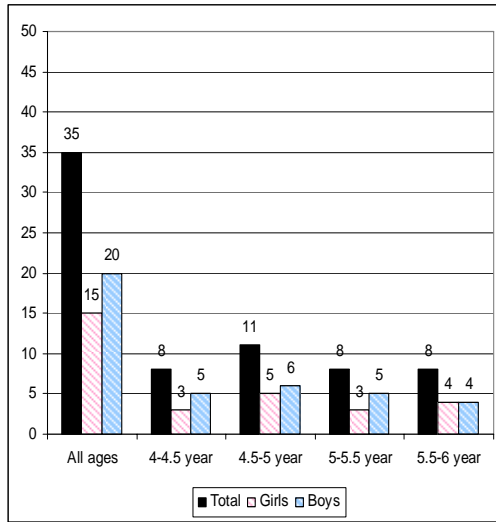

Figure C9. Number of participants.

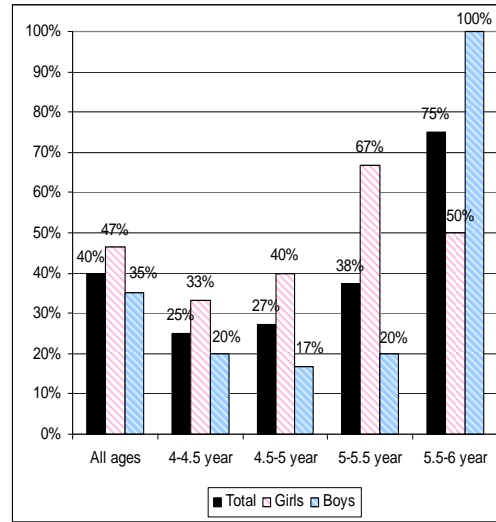

Figure C10. % of success by age.

Test barrier E: Vertical bars height 1.2 m, inclined 15° towards the climber (second attempt)

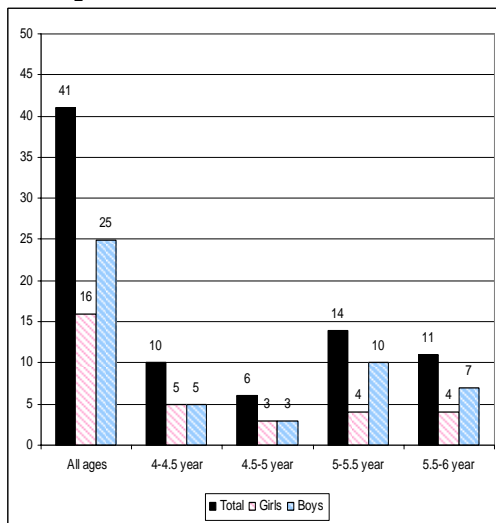

Figure C11. Number of participants.

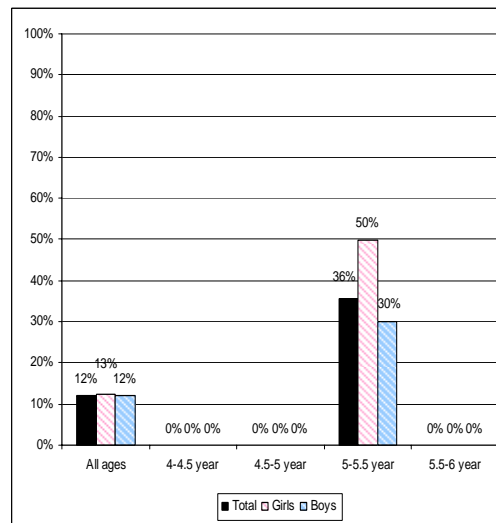

Figure C12. % of success by age.

Diagrams of result from the practical test divided by height

Test barrier A: Vertical bars, height 1.1 m (first attempt)

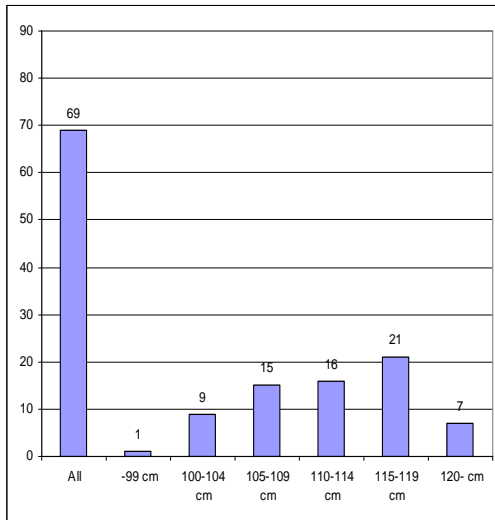

Figure C13. Number of participants.

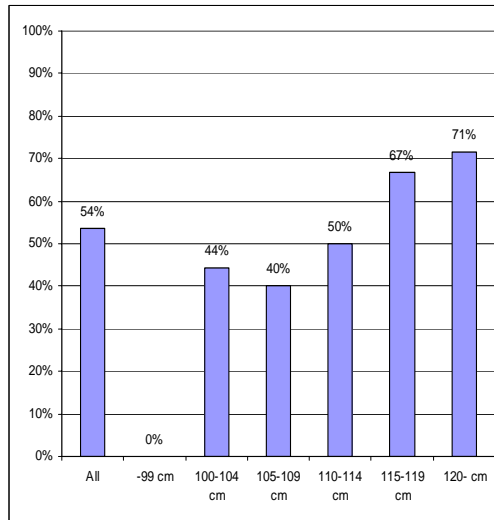

Figure C14. % of success by height.

Test barrier B: Vertical bars, height 1.2 m (first attempt)

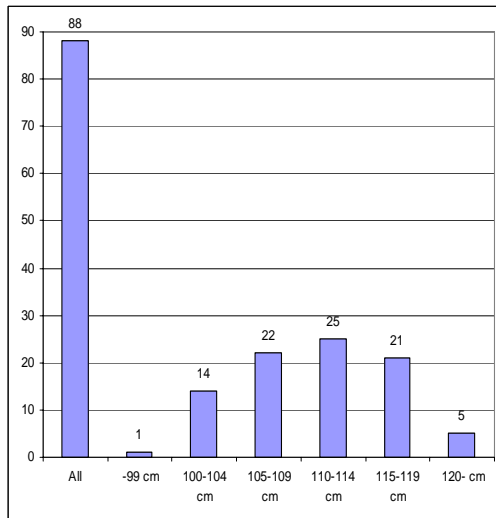

Figure C15. Number of participants.

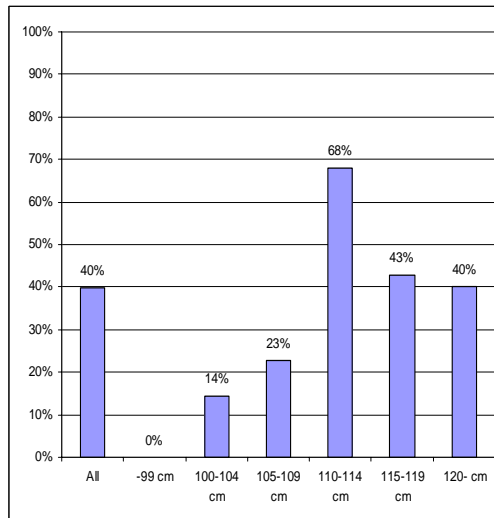

Figure C16. % of success by height.

Test structure B: Vertical bars, height of 1.2 m (second attempt)

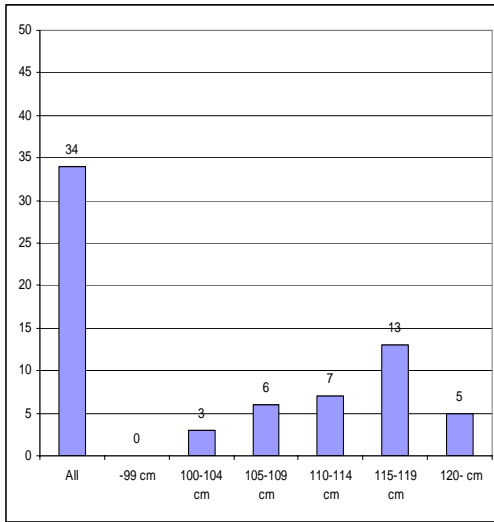

Figure C17. Number of participants.

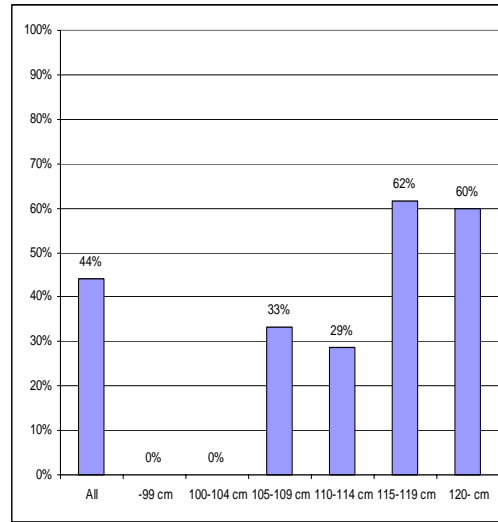

Figure C18. % of success by height.

Test barrier C: Vertical bars, height 1.2 m, 100 mm top profile (second attempt)

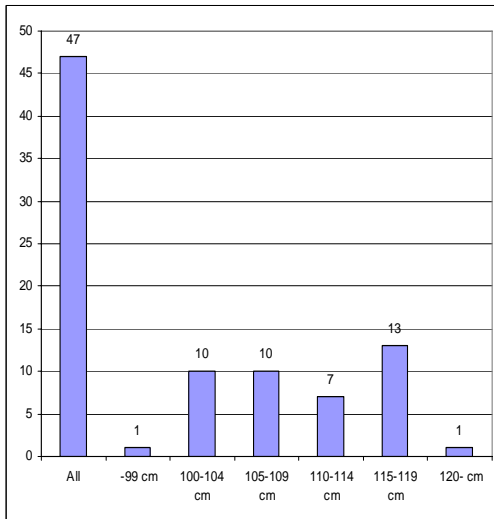

Figure C19. Number of participants.

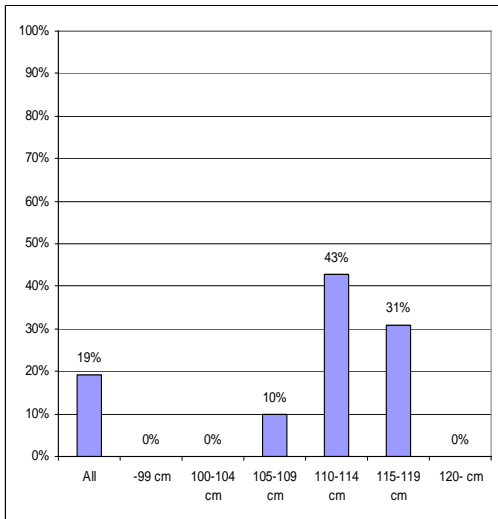

Figure C20. % of success by height.

Test barrier D: Vertical panel, height 1.2 m (second attempt)

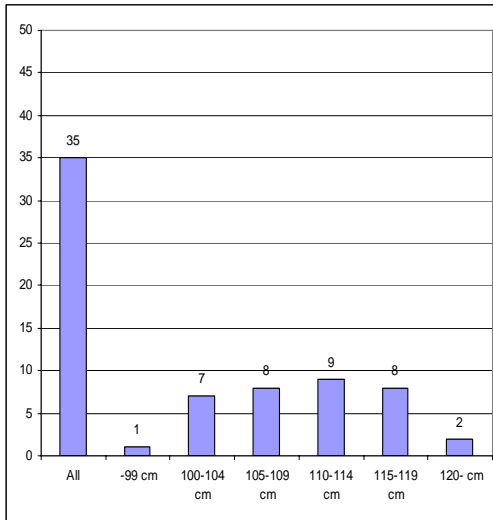

Figure C21. Number of participants.

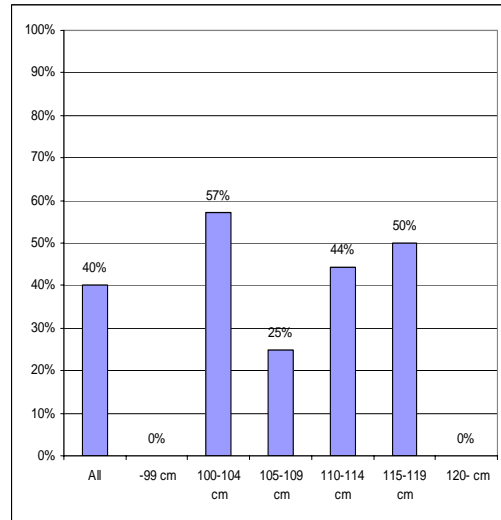

Figure C22. % of success by height.

Test barrier E: Vertical bars height 1.2 m, inclined 15° towards the climber (second attempt)

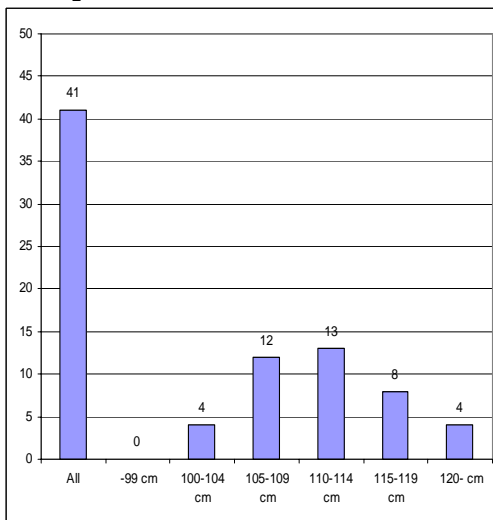

Figure C23. Number of participants.

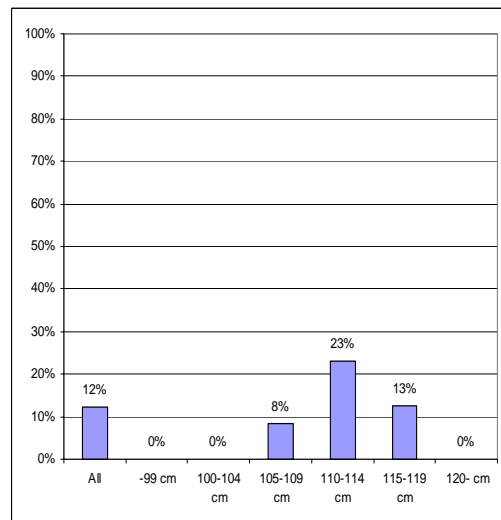
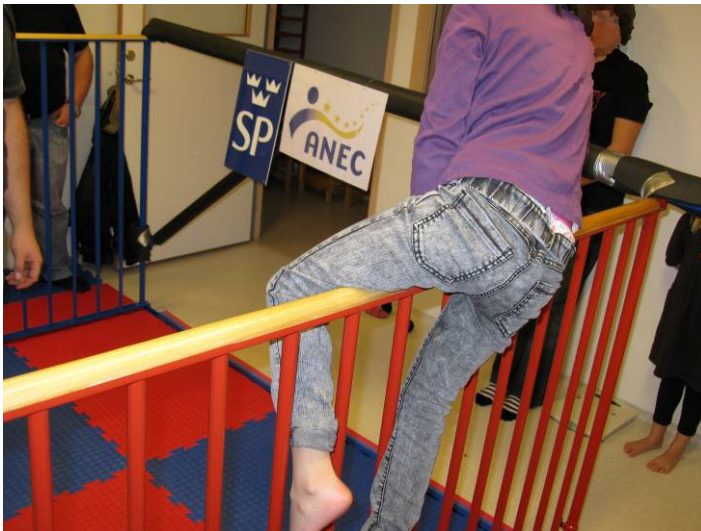

Figure C24. % of success by height.

Appendix D Photos from practical test

Test barrier A: Vertical bars, height 1.1 m (first attempt)



Test barrier B: Vertical bars, height 1.2 m (first and second attempt)



Test barrier C: Vertical bars, height 1.2 m, 100 mm top profile (second attempt)



Test barrier D: Vertical panel, height 1.2 m (second attempt)



Test barrier E: Vertical bars height 1.2 m, inclined 15° towards the climber (second attempt)



Appendix E Percentile estimation

Written by: Thomas Svensson, PhD

Consider the population of all children in the actual ages. We are interested in their ability to pass a barrier and measure this ability by the time needed for passing. This time is a number of seconds in case of success, but infinity otherwise, and is therefore not possible to characterize by the mean value and standard deviation. Instead we focus on a *percentile* in the distribution of passing times.

We can identify this situation with a test procedure that consists of n independent trials. By independent we mean that the outcome of each trial does not depend in any way on the outcome of other trials. In statistical theory, when the outcome of each trial is either a “success” or a “failure”, the trials are called *Bernoulli trials*. If the probability of success is p , then the number of successes k in n Bernoulli trials has the *binomial distribution* with parameters n and p .

For a certain percentile in our child distribution, say x_p seconds, the probability to be faster is equal to p . For each trial in the test procedure one can define “success” as the event that the child manages to pass the barrier faster than x_p seconds, and “failure” for a slower result.

By using the binomial distribution we can find a lower confidence limit for the true percentile in the whole population according to the following example: For the inclined barrier we have the following ordered result of times for passing in seconds: 13, 15, 26, 33, 72, inf., inf., ..., inf. Namely, five children managed to pass the barrier and the rest of the 41 trials failed. Now, guess that the 25th percentile equals, say, $x_p = 33$. Using the binomial distribution, we can now calculate the probability to observe not more than 3 out of 41 that is smaller than 33. The result is $0.0038=0.38\%$ ¹. This means that 33 can be regarded as a lower confidence limit for the true 25th percentile, the true percentile is expected to exceed this value with 99.62% probability.

For comparisons it is more convenient to choose a lower cover probability than 99.62% and usually one chooses 95%. However, in the given example the lowest coverage probability we can get is to choose the largest observed time, 72. So, a new guess is $x_p = 72$ and we obtain the probability that not more than 4 out of 41 is smaller than 72: 1.3%, giving a 98.7% lower confidence limit². Since this example is the one with least number of successes among our barriers, we now calculate the corresponding confidence limits for the other barriers:

barrier	number of trials	number of successes to get appr. 98.7% probability	Probability, %	Lower confidence limit, seconds
1.1 m	69	9	98.9	8
1.2 m, first attempt	88	13	98.5	17
1.2 m, second attempt	35	3	98.6	13
1.2 , wide	46	5	98.5	11
1.2 m, panel	35	3	98.6	11
1.2 m, inclined	41	4	98.7	72

¹ In e.g. Microsoft Excel 2003 “=BINOMFÖRD(3;41;0.25;1)” is used.

² The reason for choosing the 25th percentile is that this gives the opportunity to get corresponding values for all barriers for comparison.

SP Sveriges Tekniska Forskningsinstitut utvecklar och förmedlar teknik för näringslivets utveckling och konkurrenskraft och för säkerhet, hållbar tillväxt och god miljö i samhället. Vi har Sveriges bredaste och mest kvalificerade resurser för teknisk utvärdering, mätteknik, forskning och utveckling. Vår forskning sker i nära samverkan med högskola, universitet och internationella kolleger. Vi är ca 870 medarbetare som bygger våra tjänster på kompetens, effektivitet, opartiskhet och internationell acceptans.



SP är organiserat i åtta tekniska enheter och sex dotterbolag varav CBI, Glafo och JTI ägs till 60 % av SP och 40 % av industrin.



SP Sveriges Tekniska Forskningsinstitut

Box 857, 501 15 BORÅS

Telefon: 010-516 50 00, Telefax: 033-13 55 02

E-post: info@sp.se, Internet: www.sp.se

www.sp.se

Bygg och Mekanik

SP Rapport 2009:32

ISBN 91-7848-978-91-86319-20-

5

ISSN 0284-5172